

Operating Manual Adsorption Dryer DPS 1-8

Version: 07/2014/EN





Table of contents

1.	General information	5
1.1	Manufacturer.....	5
1.2	Dryer data.....	6
1.3	Contact data	6
1.4	Additional documents	6
1.5	Warranty notes.....	7
1.6	About this operating manual.....	7
2.	Description of application	9
2.1	Intended use.....	9
2.2	Technical data.....	11
3.	Safety notes	12
3.1	Signs and instructions.....	12
3.2	Danger zones at the dryer	13
3.3	General safety notes.....	14
4.	Technical product description	16
4.1	Assembly drawing.....	16
4.2	Process flow diagram.....	18
4.3	Nozzle table	19
4.4	Function description.....	20
4.5	Options	24
5.	Operating elements.....	25
5.1	Power connector	25
5.2	Differential pressure gauges on the filters.....	26
5.3	Pressure gauge	26
5.1	Control System	27
5.1.1	Function Keys and Display	27
5.1.2	Direct Indication	28
5.1.3	Menu Navigation	29
5.1.4	PARAMETER Level.....	29
5.1.5	SERVICE Level.....	34
5.1.6	Compressor Synchronisation Function.....	35
5.1.7	Pressure Dew Point Measurement and Energy-saving Function	36
5.1.8	Differential Pressure Monitoring of Filter	38
5.1.9	Overflow Monitor	38
5.1.10	Service Ticket.....	38
5.2	Allocation Text on Display / Triggering of Valves	39
5.3	Failure Analysis	42
6.	Transportation, setting up and storage.....	45
6.1	Transportation.....	45
6.2	Setting up.....	46
6.3	Storage.....	47
7.	Installation	48
7.1	Installing the connecting pipelines.....	48
7.2	Installing the power supply	50
8.	Commissioning	53

Table of contents

8.1	Requirements for initial commissioning.....	53
8.2	Commissioning the dryer.....	54
8.2.1	Pressurisation of the dryer	55
8.2.2	Opening the outlet valve	55
8.2.3	Starting the dryer.....	56
9.	Shutting down and restarting the dryer	57
9.1	Shutting down the dryer in case of emergency.....	57
9.2	Stopping the dryer	57
9.3	Shutting down the dryer.....	57
9.4	Depressurising the dryer	58
9.5	Restarting the dryer.....	58
10.	Maintenance and repair	59
10.1	Regular maintenance intervals.....	60
10.1.1	Visual check and function monitoring.....	60
10.1.2	Cleaning the dryer and dryer control	61
10.1.3	Checking if cable and terminals are securely fixed.....	61
10.1.4	Calibrating the dew point sensor.....	61
10.1.5	Replacing filter elements.....	62
10.1.6	Replacing the expansion silencer	62
10.1.7	Replacing the sealing set of the valves (V1-4) and the check valves (RV1-2).....	63
10.1.8	Checking and replacing the desiccant	63
11.	Appendix and technical documents	66
11.1	Manufacturer's declaration.....	66
11.2	Declaration of conformity	67
11.3	General arrangement drawing	68
11.4	Process flow diagram.....	68
11.5	Wiring diagram	68



1. General information

1.1 Manufacturer



FST GmbH

Head office: Weiherdamm 17 – 57250 Netphen, Germany

Sales office: Im Teelbruch 106 – 45219 Essen, Germany

☎ +49 (0) 2054 8735-0

📠 +49 (0) 2054 8735-100

✉ info@fstweb.de

! For any questions about the product, please contact the sales office !

In case of questions about the product, please specify the type and the manufacturing number. This information can be found on the type plate over the control box of the dryer. (→Page 12)

General information

1.2 Dryer data

Model:	
Order no.:	
Manufacturing no.:	
Vessel no. (left/right):	
Year of manufacture:	
Date of commissioning:	

1.3 Contact data

Name:	
Company:	
Address:	
Phone / Fax:	
E-mail:	

The above dryer data differs for each dryer. Please fill in the fields according to the type plate and your contract documents. This data enables the manufacturer to clearly identify the dryer and simplifies service and provision of the proper spare parts.

Some of the information listed here and other important data can be found on the type plate of the dryer and on the type plate of the vessels. (→Page 12)

1.4 Additional documents

- General arrangement drawing
- Process flow diagram
- Wiring diagram
- CE-declaration of conformity

1.5 Warranty notes

For warranty information, please refer to our "General Terms of Sale and Delivery".

(→ www.fstweb.de)

In the following cases the warranty shall be void:

- If the safety notes and instructions of this operating manual and of the additional documents are not observed.
 - If the dryer is operated or maintained by personnel who do not have the required qualifications. (→ see "Target group": (→ see "target group":Page 7)
- If the dryer is used for anything other than its intended use. (→ Page 9)
- If aggressive substances in the compressed air or ambient air cause damage to the dryer.
- If parts other than genuine parts of the manufacturer have been used for maintenance and repair.
- If the dryer is operated although defects are evident.

1.6 About this operating manual

This operating manual contains all the technical information required for installation, operation, maintenance and disposal of the dryer.

Target group

This operating manual is directed to all persons working on and with the dryer. We point out that these persons have to be qualified personnel who, because of their qualification and experience, are familiar with handling compressed air systems and electrical systems. If you are not experienced in using these systems, please ask the relevant experts for help. We highly recommend that commissioning and maintenance be carried out by the manufacturer or one of the authorised service partners.

Using the operating manual

Please read the operating manual and the additional documents carefully prior to installation and follow the notes and instructions. Safe and proper operation of the dryer can only be guaranteed if the instructions and notes are observed. The safety notes must be observed in particular.

The operating manual must be kept in the vicinity of the dryer and must be easily accessible.

When selling or hiring out the dryer, also provide this operating manual and all the additional documents to the new user. (→Page 6)

The manufacturer accepts no liability for damages resulting from disregard of the operating manual.

All the information in this operating manual is valid at the time the manual is published. Due to component or workflow modifications at any time affecting dryer maintenance, the latest information should be available prior to maintenance work.

General information

Signs and symbols used

- Boxes are used for bulleted lists.
- 1) Enumerated lists point out that the working steps are to be carried out in a specified order.
- Cross references refer to information on a different page or in a different document.



Note!

This symbol refers to matters that should be given special attention. Observing the notes helps to ensure safe handling of the product.



Tips and hints!

This symbol refers to matters that should be given special attention. Observing these advisory notes helps to ensure particular efficient operation of the product.



CAUTION !

This symbol indicates a possible harmful situation. When not avoiding this situation, there is a danger of injury or damage to the product or to adjacent system components.



WARNING !

This symbol indicates a possible dangerous situation. When not avoiding this situation, there is a danger of serious injury or death.



DANGER !

This symbol indicates an immediate impending danger. Not avoiding this danger results in serious injury or death.

2. Description of application

The dryer is used to remove moisture from compressed air for industrial use.

Typically, the dryer is used for drying compressed air from a compressor station.

During pre-treatment of the compressed air by means of separators and fine filters only the liquid water components can be removed from the compressed air. After this pre-treatment the dryer also removes the vaporous water components. The compressed air is dried until only a very low residual concentration of water vapour remains in the dried compressed air. This residual moisture content is measured as the pressure dew point in °C.

The dryer works completely automatically and is designed for continuous operation. Thanks to numerous communication interfaces and an optionally available moisture measuring system the dryer can be operated very economically.

2.1 Intended use

The dryer is exclusively designed for drying compressed air!

Using the dryer for drying other gases (e.g. pure nitrogen) must be agreed on with the manufacturer. It may be necessary to observe special safety directives.

The dryer is designed to be set up at a site that complies with the following requirements:

- Indoors
- Protected against weather impact
- Frost-free
- Dry
- Zero to low dust-laden ambient air
- No vibration via floor or connected piping
- Ambient air must be free from aggressive and corrosive substances
- Ambient air must be free from substances that damage the desiccant or influence its effectiveness (e.g. ammonia or other alkaline-reacting substances, oil mist, water spray or drizzle)
- Free from dangers due to explosive atmospheres inside and outside the dryer. (The standard dryer version does not comply with ATEX.)

The dryer must only be operated with compressed air within the maximum allowable operating conditions.

The voltage supply must correspond to the specified values.

The maximum allowable operating conditions and the required voltage supply are specified on the type plate (→Page 12).

Modifications to the dryer or use of third-party parts may cause unpredictable danger and damage. These measures must only be carried out after previous check and approval of the manufacturer. Only use genuine spare parts of the manufacturer.

Any other use is considered improper and therefore not permissible. The manufacturer accepts no liability caused by improper use.

Description of application

The values specified on the type plate are mechanical design limits.

Please note that dryer performance is not defined to these mechanical design limits. Dryer performance is guaranteed for use under the "nominal operating conditions" as well as for a certain combination of the individual operating parameters, that has been established for this dryer in the planning phase (compressed air flow rate, pressure, temperature, desired pressure dew point).

For the nominal operating conditions please refer to the following table. (→Page 11)

For a dryer designed to your individual operating conditions, please refer to your contract documents or contact the manufacturer.

Dryer performance cannot be guaranteed if the dryer is not operated within these operating conditions.

The supplied compressed air must be of the following quality:

- Free from aggressive and corrosive substances
- Filtered acc. to ISO 8573-1:2010 (1:*:3)
- Free from substances damaging the desiccant

*= The compressed air should be saturated with moisture or only be slightly subsaturated. When using pre-dried compressed air (e.g. downstream of a fridge dryer) the dryer performance may be reduced.

During initial commissioning and after desiccant replacement in particular, pre-dried compressed air may negatively affect dryer performance.

TIPP

In the event of pre-dried compressed air

For some days, operate the dryer using moisture-saturated compressed air in order to activate the desiccant. For this activation process the dryer control system should be set as follows:

- 1) Select the "**variable**" cycle mode. (→ Page **Fehler! Textmarke nicht definiert.**)
- 2) Select a **dew point** limit value that can still be tolerated, however, it must not be worse than -10°C. (→ Page **Fehler! Textmarke nicht definiert.**)

The dew point should become better within the next days.

- 3) Monitor the development of the dew point measured value for some days.
- 4) Select a **dew point** limit value that is approximately 10°C worse than the dew point that is usually reached, however, it must not be worse than -10°C.

Usually, dryer performance will be adequate after this procedure even when using pre-dried compressed air. If the dew point becomes worse again at a later point in time, the procedure must be repeated.

Example:

- The dryer is to be reaching a dew point of -40°C. However, in most cases it only reaches -30°C.
- Select the "**variable**" cycle mode and then a **dew point** limit value of -20°C.
- The adsorption phases of the dryer are now very long and thus the dryer is increasingly laden with moisture.
- After some days the dew point becomes better and reaches values around -55°C.

Now, select a **dew point** limit value of -40°C. The dryer should now permanently be reaching good dew points.

2.2 Technical data

Dryer	Nominal volume flow rate	Compressed air connection	Weight	Height	Width	Depth
	V [m ³ /h]*		[kg]	[mm]	[mm]	[mm]
DPS 1	8	G 3/8"	11	450	312	185
DPS 2	15	G 3/8"	15	625	312	185
DPS 3	25	G 3/8"	20	875	312	185
DPS 4	35	G 3/8"	25	1125	312	185
DPS 6	57	G 1/2"	45	1180	484	220
DPS 7	72	G 1/2"	54	1405	484	220
DPS 8	82	G 1/2"	62	1605	484	220

* = Standardised to 1 bar(a) and 20°C as well as to the following operating conditions: 7 bar operating overpressure, 35°C inlet temperature and -40°C pressure dew point

Classification acc. to PED 97/23/EG	DPS1...2: Art.3 Par.3 / DPS3...8: I
Fluid group	2
Supply voltage	230V 50-60Hz (optional 115V 50-60Hz and 24V-DC)
Class of protection	IP65
Min. / max. allowable pressure (PS)	4 to 16 bar
Min. / max. allowable temperature (TS)	+1 to +50°C
Noise pressure level (free-field measurement in distance of 1 m)	up to 85 dB(A)



Individual operating conditions

Please contact the manufacturer when your operating conditions are not within the limits stated above.

Options adapting the dryer to your operating conditions can be provided for numerous special cases.

3. Safety notes

The dryer has been built according to state-of-the-art technology and recognised safety rules. However, there is a risk of danger that every person working with the dryer must be aware of. In particular, improper handling of compressed air and electricity may result in serious injury or death. If you are not experienced in using these systems, please ask the relevant experts for help..



Note!

- In order to prevent personal injury or damage, the safety notes must be observed when using this dryer.
- Observe the specific safety notes in the relevant chapters.
- Observe the legal guidelines and the accident prevention regulations.
- Observe the safety notes of the local site regulations.

3.1 Signs and instructions

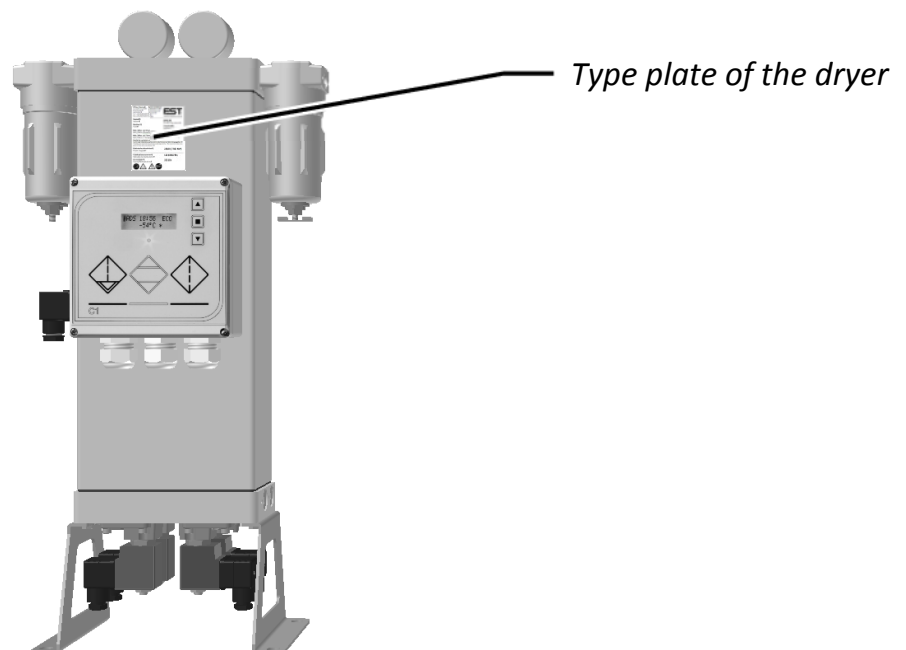

The type plates show important information. Make sure that the type plates are always clearly readable.

3.2 Danger zones at the dryer

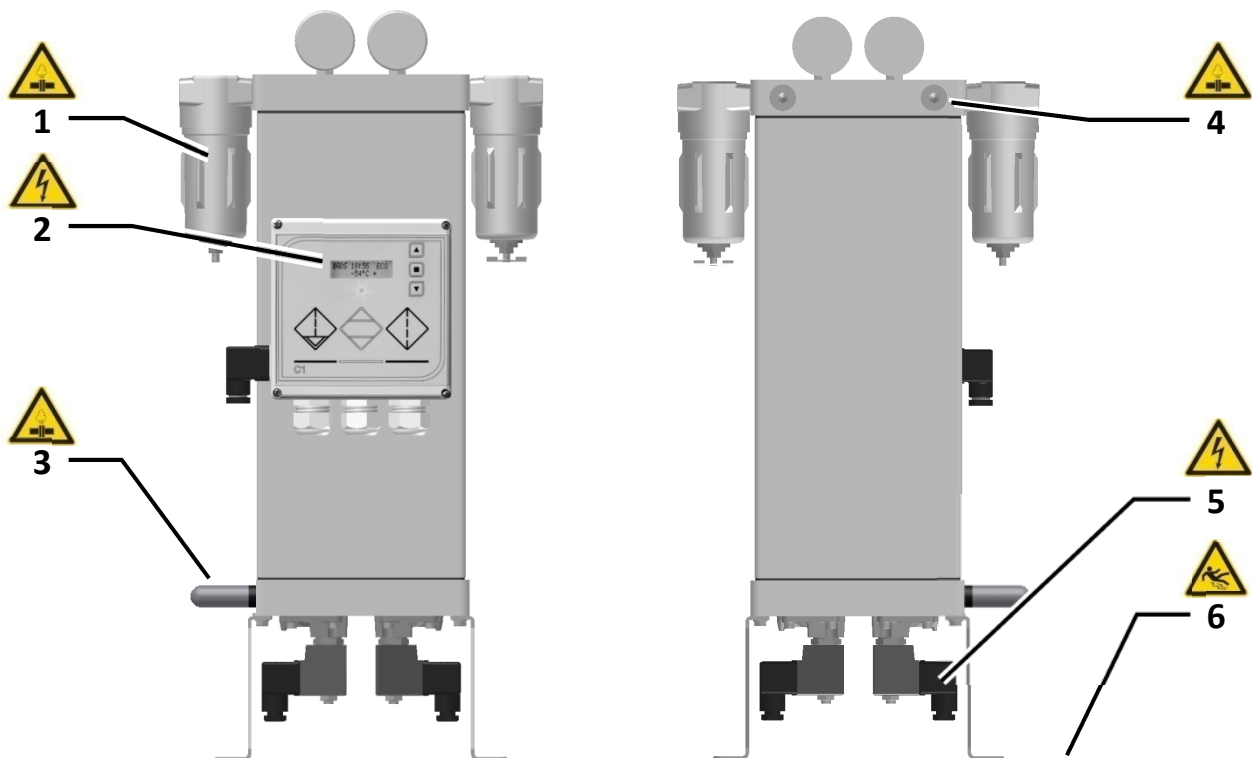

- 1;4** Gefahr durch drucktragende Teile
- 2;5** Gefahr durch elektrische Spannung
- 3** Gefahr durch plötzlich entweichenden Druck
- 6** Rutschgefahr durch verschüttetes Trockenmittel



DANGER ! – Overpressure (1,4)

The dryer is under pressure.

Suddenly escaping compressed air may result in serious injury.

Do not carry out mechanical or electrical work on the dryer as long as the dryer is under pressure.



DANGER ! – Electric voltage (2;5)

The dryer is operated electric voltages up to 230 V.

Touching live parts may result in serious injury or death.



Work on electrical components must only be carried out by qualified and authorised personnel.

Use a voltage detector to make sure the dryer has been disconnected from the power supply and that there are no live parts before starting maintenance work.



In the event of fire, do not extinguish the fire using water.

Safety notes



WARNING ! – Suddenly escaping compressed air (3)

The dryer is depressurised approximately every 6 hours using a silencer. A loud and strong air-stream may carry small particles and cause injury.



Do not place any equipment in the vicinity of the silencer. The silencer must not be manipulated or removed. Always wear hearing protectors when working in the vicinity of the dryer.



WARNING ! – Risk of slipping (6)

After desiccant replacement some amounts of desiccant may still remain on the floor.

The desiccant is very slippery and may result in serious fall injury.

Immediately remove residual desiccant properly from the floor.

3.3 General safety notes



DANGER ! – Overload

The dryer must only be operated with compressed air within the maximum allowable operating conditions. The operating conditions are defined on the type plate (→ page 12).

Exceeding the maximum allowable operating conditions may result in serious injury or death.

It is the duty of the operator to ensure that the connected pressure source is safe-guarded such that the maximum allowable operating pressure (PS) and the maximum allowable temperature (TS) are not exceeded.

Please also refer to section "Intended use" (→ page 9).



DANGER ! – Unauthorised modifications

Modifications to the dryer or the dryer control system may result in dangerous operating states. Violations may cause serious injury or death.

Never modify the dryer function by means of conversions.

Never carry out welding work on pressure-bearing parts.

Never change the control program of the dryer.

Any modifications of the dryer must be agreed on with the manufacturer and confirmed in writing.



DANGER ! – Suspected misuse

Using the dryer for unintended purposes may result in dangerous situations. Violations may cause serious injury or death.

Never use the dryer as a climbing aid.

Never use the dryer as a support for external weight loads.

Never use dryer components for unintended application purposes.

Please also refer to section "Intended use" (→ page 9).



WARNING ! – Risk of falls

The dryer must never be used as a climbing aid. The dryer components will not provide adequate support and parts of the dryer may break off. Disregard may lead to dryer damages and falls with serious injuries.

When working at height only use approved climb assist systems.

**CAUTION ! – Desiccant dust**

Using the desiccant may lead to mineral dust formation.
Desiccant dust may cause eye and respiratory tract irritations.
Wear eye protection and a dust mask when handling the desiccant.

**Desiccant**

The desiccant used is not subject to labelling requirements according to the Hazardous Substances Ordinance. Nevertheless, the common safety measures with regard to using chemicals apply. The manufacturer will provide safety data sheets on request.

The desiccant may accumulate contaminants from the compressed air. Depending on the type of contamination there may be a risk of injury or damage when using the desiccant. As the type of contamination is not known to the manufacturer, the resulting risks cannot be evaluated in this operating manual.

**Additional safety notes**

For additional safety notes, please refer to the relevant chapters.

4. Technical product description

4.1 Assembly drawing

Front View

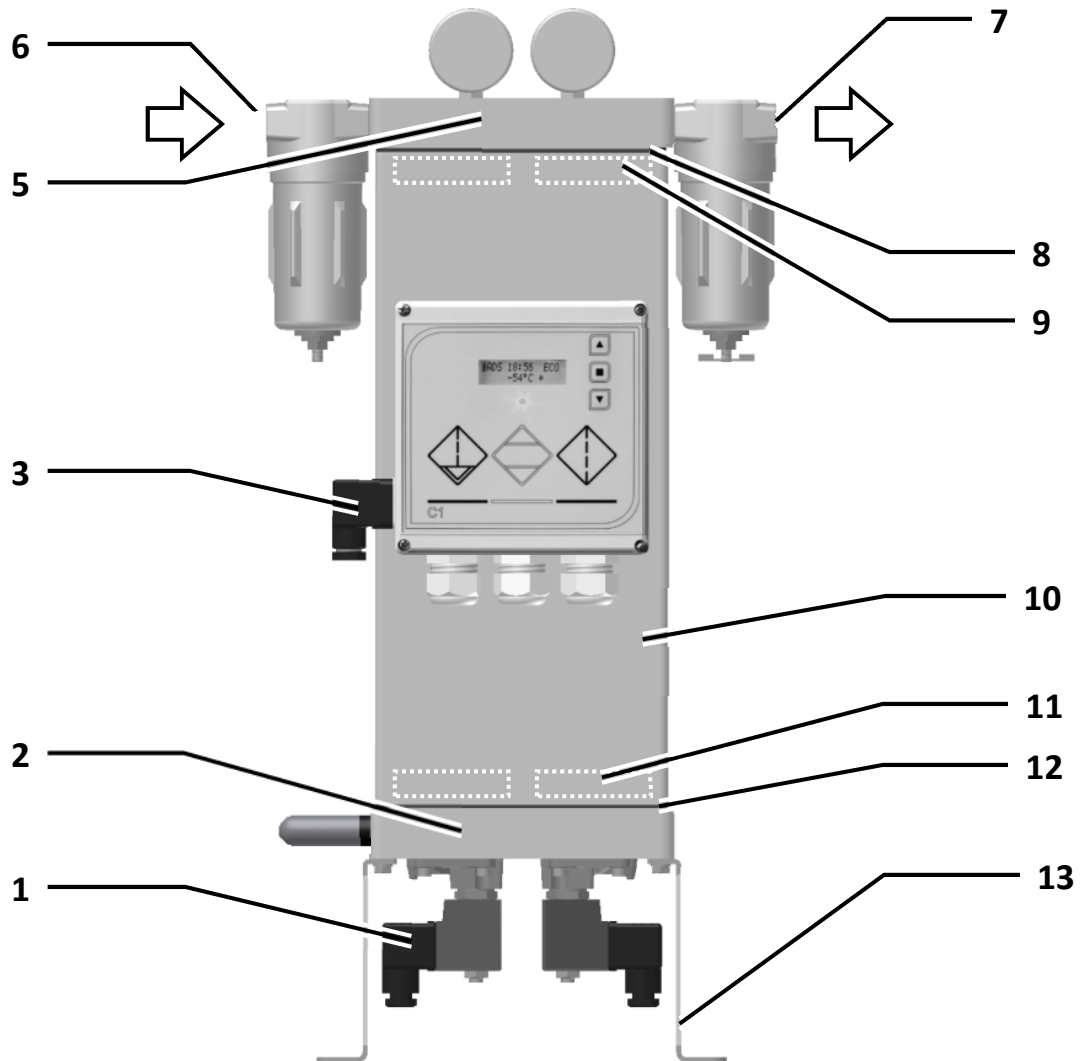

- 1** Solenoid valves (solenoids: Y1, Y2, Y3, Y4)
- 2** Lower valve block (V1, V2, V3, V4)
- 3** Power Connector (power supply)
- 4** Control with display and operator keys
- 5** Upper check valve block (RV1, RV2) with orifices (O1, O2)
- 6** Compressed air inlet (GJ)

- 7** Compressed air outlet (GO)
- 8,12** Flat gasket
- 9,11** Demister-Pads (SD1), internal
- 10** Twin vessel (A1, A2)
- 13** Dryer support legs

Rear view

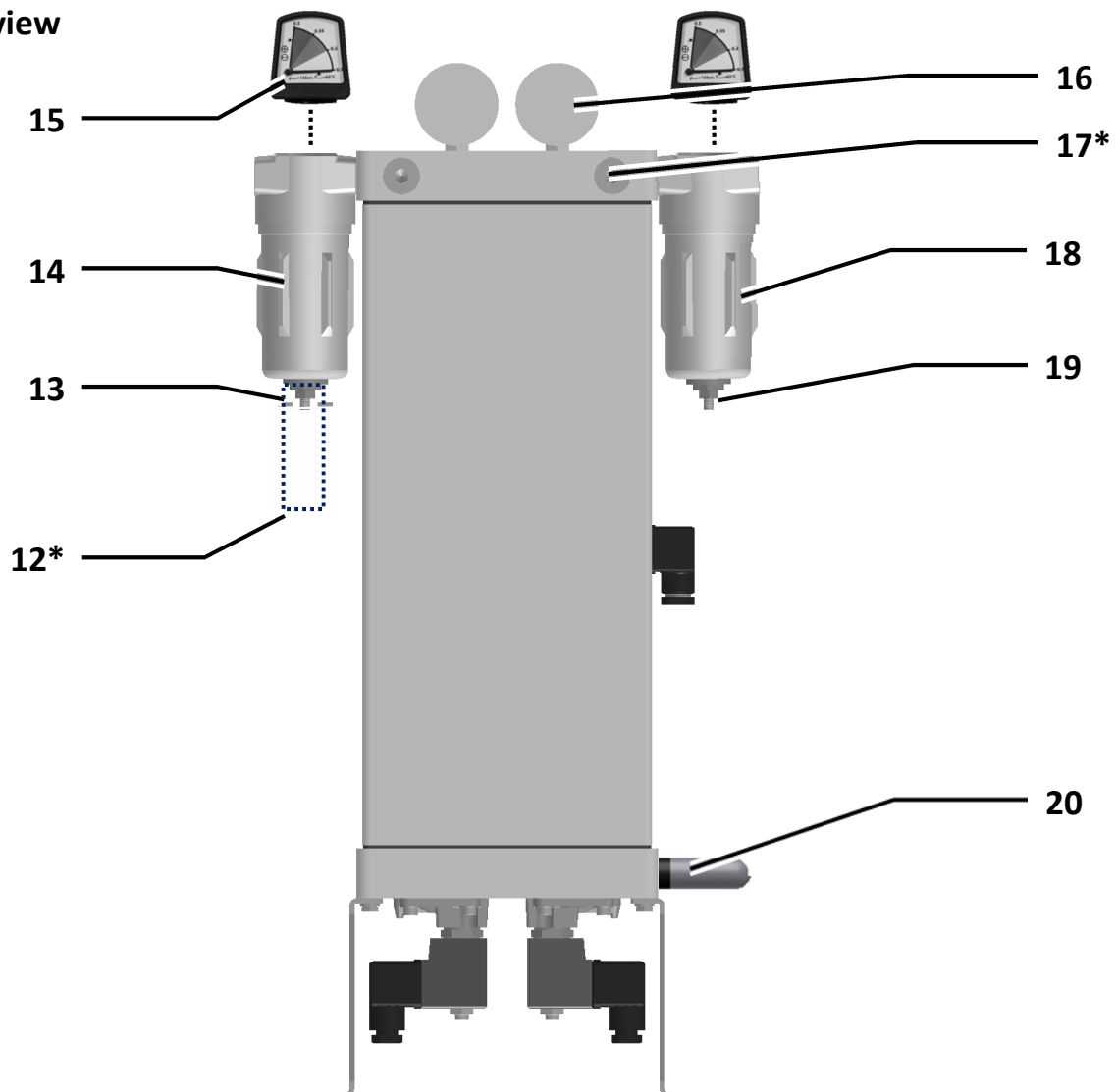

- | | | | |
|-----------|---|-----------|---|
| 12 | <i>Dew point sensor (MT01) (*optional)</i> | 17 | <i>Connection for regeneration back-feed-line (RV3) (*optional)</i> |
| 13 | <i>Manual drain valve (HV1) on after-filter</i> | 18 | <i>Pre-filter(F1) with filter element</i> |
| 14 | <i>After-filter (F2) with filter element</i> | 19 | <i>Condensate drain (D1) and Condensate outlet (CO)</i> |
| 15 | <i>Differential pressure gauge (DPI01, DPI02)
Note: only for DPS6-8</i> | 20 | <i>Expansion silencer (X1) with regeneration gas outlet (RO)</i> |
| 16 | <i>Pressure gauge (PI01, PI02)</i> | | |

Technical product description

4.2 Process flow diagram

Symbolic diagram of the dryer components, their locations and interconnections.

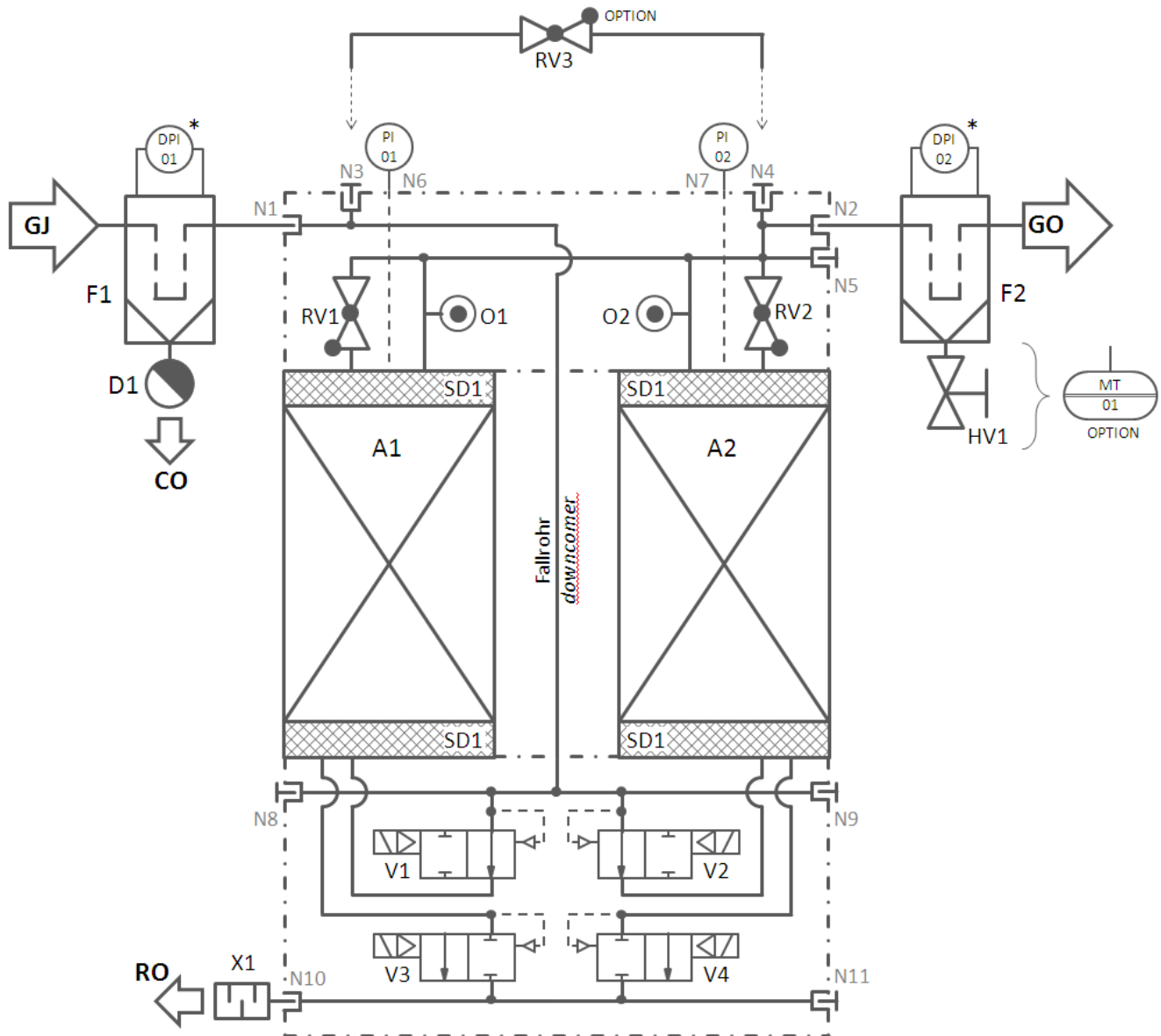

- | | | | |
|----|-----------------------|-----|-----------------------------|
| A | Dryer twin vessel | O | orifice |
| F | Filter | PI | Pressure gauge |
| V | Valve | DPI | Differential pressure gauge |
| HV | Manual valve | MT | Dew point transmitter |
| RV | Check valve | GJ | Gas inlet |
| SD | Sieve mesh / demister | GO | Gas outlet |
| X | Expansion silencer | RO | Regeneration gas outlet |
| D | Condensate drain | CO | Condensate outlet |

4.3 Nozzle table

The valve block comprises several connections, which can be used alternatively to the standard connections.

	DPS 1-4	DPS 6-8	Function
GJ	3/8"	1/2"	inlet
GO	3/8"	1/2"	outlet
CO	1/8"	1/8"	Condensate outlet
N1	3/8"	1/2"	Dryer inlet
N2	3/8"	1/2"	Dryer outlet
N3	3/8"	1/2"	Inlet for regeneration back-feed-line Dryer inlet, alternative connection 1
N4	3/8"	1/2"	outlet for regeneration back-feed-line Dryer outlet, alternative connection 1 Dew point sensor MT01, alternative connection 1
N5	3/8"	1/2"	Dryer outlet, alternative connection 2
N6	1/8"	1/8"	Pressure gauge vessel A1
N7	1/8"	1/8"	Pressure gauge vessel A2
N8	3/8"	1/2"	Dryer inlet, alternative connection 2
N9	3/8"	1/2"	Dryer inlet, alternative connection 3
N10	3/8"	1/2"	Expansion Regeneration gas outlet
N11	3/8"	1/2"	Expansion - Regeneration gas outlet, alternative connection 1

Technical product description

4.4 Function description

The operation principle of the dryer is adsorption. The principle of moisture adsorption is water molecules being attracted to a hygroscopic solid material (desiccant). This process is reversible and, after a regeneration phase, the desiccant can be reused for drying.

For compressed air drying the compressed air flow is led through a vessel containing the desiccant and brought into intensive contact with the desiccant. The desiccant removes moisture from the compressed air and stores it in its internal structure. With continuous moisture loading of the desiccant the dryer performance is reduced until the desiccant is saturated with moisture. The saturated desiccant then requires regeneration, i.e. the moisture stored in the inner desiccant structure is removed again. The desiccant can then be reused for drying.

Continuous operation of an adsorption dryer requires two vessels that are operated alternately. One vessel is used for drying the compressed air (adsorption). In the other vessel the regeneration phases are carried out. The change interval between adsorption and regeneration is approx. 5 Minutes*.

Adsorption phase

Duration approx. 3 Minutes to max. 2 hours*

The moist compressed air is supplied from a compressed air source (e.g. compressor) to the compressed air inlet (GJ) of the dryer. The pre-filter (F1) removes dust and liquids from the compressed air flow. The lower valve block (V1-4) forwards the compressed air to the vessel which is in "adsorption" mode (here A2). In the lower part of the vessel the compressed air is decelerated and distributed over the vessel cross-section. The compressed air passes the demister pad (SD1) and slowly flows through the desiccant bed. The compressed air exits the vessel via a second demister pad (SD1) and is forwarded from the upper checkvalve block (RV1, RV2) to the compressed air outlet (GO).

The optional dew point sensor (MT01) checks the dryer performance at the compressed air outlet.

During this time the second vessel is in standby mode and waits for operation.

The adsorption phase is completed and the vessels are switched over if...

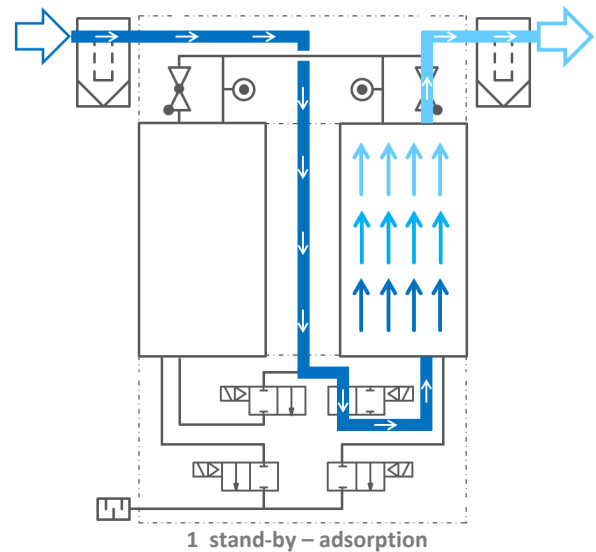

- ... the cycle mode **“CYCLE MODE – FIX”** has been pre-selected and a time of 5 minutes has expired.
- ... cycle mode **“CYCLE MODE – VAR”** has been pre-selected and optional dew point measurement has reached the selected limit value. The maximum allowable duration of the adsorption time is gradually increased as long as the dew point stays good. Switch-over of the vessels is carried out compulsorily after 2 hours at the latest.

For vessel switch-over the main valves (V1) is opened and shortly later the main valve (V2) is closed. The compressed air flows from one vessel to the other. A free flow path through the dryer is available at any time during switch-over. As a result, the task of drying is passed on to the other vessel without interruption.

Now vessel (A2) has gone "offline" and vessel (A1) has gone "online".

Regeneration

Duration approx. 5 min*

After the "wet" vessel (A2) has completed the adsorption phase and passed on the task to the second vessel (A1), the first vessel (offline vessel) runs the regeneration phases.

Regeneration is divided into the following phases:

- Expansion
- Purging (regeneration)
- Pressurisation
- Standby

Expansion phase

Duration a few seconds*

After vessel switch-over the expansion valve (V4) is opened and the "wet" vessel is depressurised. Via the silencer (X1) the compressed air flows to the outside.

The next phase begins a after the vessel pressure has almost reached atmospheric pressure.

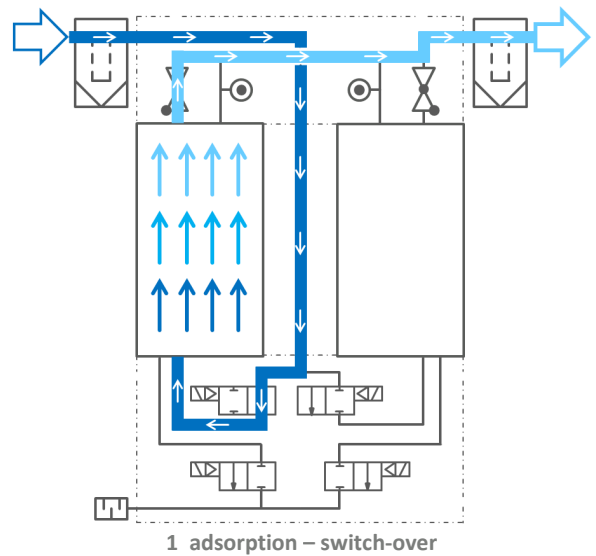

1 adsorption - switch-over

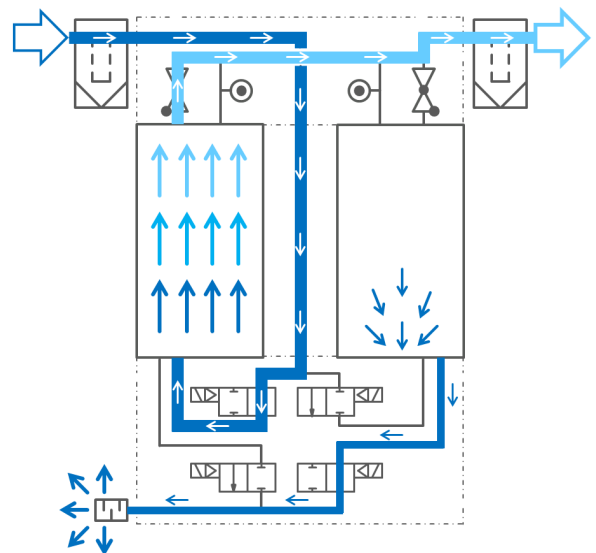

2 adsorption - expansion

Technical product description

Purging (regeneration)

Duration approx. 4 min*

When the vessel pressure drops, dry air (regeneration gas) from vessel (A1) flows through the orifice (O2) into vessel (A2).

The dry and pressureless regeneration gas is distributed throughout the vessel cross-section and led through the desiccant. The dry regeneration air vaporises the water stored in the desiccant. In the form of steam the water, together with the regeneration air flow, is then led via valve (V4) to the regeneration outlet (RO).

The wet regeneration gas is led via the expansion silencer (X1) to the outside

After a preset time of app. 4 minutes* has expired the purge phase is ended and the next phase begins.

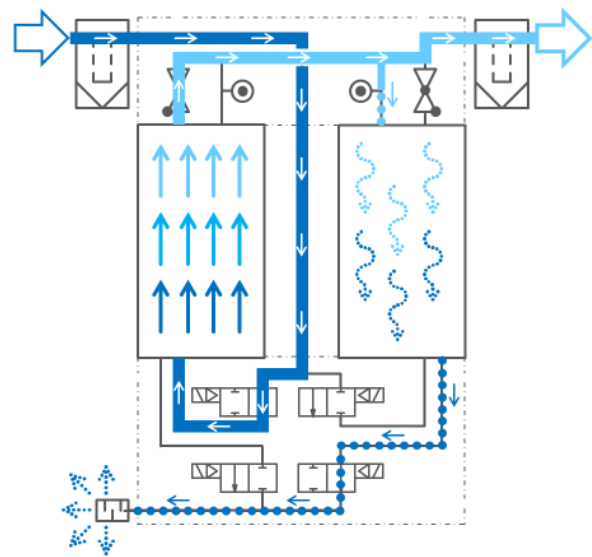

4 adsorption – purging (regeneration)

Pressurisation phase

Duration approx. 1 min

The pressurisation phase ensures that the two vessels have the same vessel pressure prior to vessel switch-over.

The regeneration air valve (V4) is closed and dry compressed air continues to flow through orifice (O2) into vessel (A2) gradually equalising the pressure in both vessels.

The next phase begins when the vessel pressure is almost the same in both vessels.

After a preset time of app. 1 minute* has expired the pressurisation phase is ended and the next phase begins.

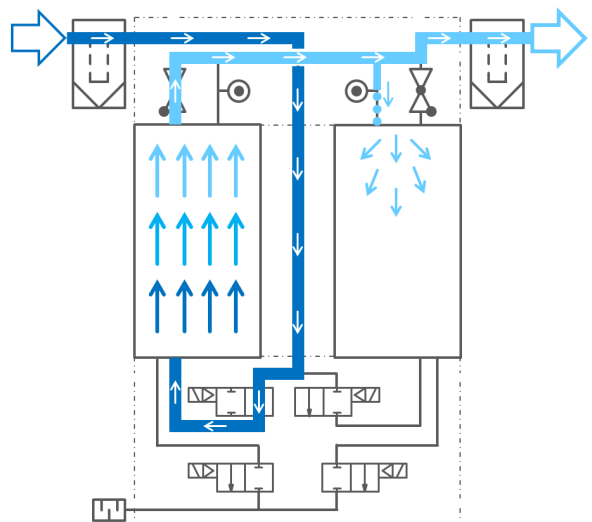

5 adsorption – pressurisation

Standby

Duration approx. 0 minutes to max. 2 hours

Vessel regeneration is now complete and the vessel is immediately ready to operate. During this phase the both vessels stay connected via the orifice (O1) and (O2). Thus the pressure in both vessels stays equal throughout the complete stand-by phase.

When the current adsorption phase has been completed, the vessels are switched over and the process is restarted.

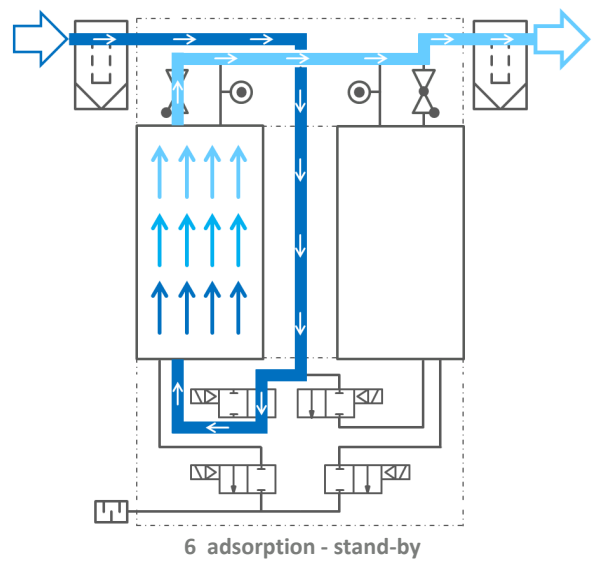

* : Note

The above time values are variables which can be pre-set individually for each dryer. Therefore, deviations from the above mentioned values are possible

4.5 Options

Various options are available for improved operation and special installation site conditions. For detailed information on the options or dryer modification to meet your operating and installation site requirements, please contact the manufacturer or the responsible sales partner

Dew point sensor

Control of the adsorption phases changes from purely time-dependent vessel switch-over to load-dependent operation when using the dew point sensor. The dew point sensor allows for considerable energy savings and increased dryer performance.

Use of a dew point sensor is highly recommended.

Automatic start-up device (pressure maintaining valve)

The dryer must always be operated with an adequately high pressure in order to avoid excessive flow velocities in the dryer. There is a danger of damage to the dryer. (→ Page 55)

If the dryer is started against a pressureless compressed air network, the compressed air network must be filled through the dryer. To ensure adequate operating pressure in the dryer the manual valve behind the dryer must be throttled and only be opened very slowly.

In the event the dryer is frequently started against pressureless compressed air networks (e.g. after the weekend) or if there is no personnel available for the start-up procedure, an automatic start-up device is useful. It ensures that there is an adequately high pressure in the dryer at any time during operation.

Regeneration gas back-feed-line

The valve arrangement in the upper check valve block obstructs any reverse flow of compressed air through the dryer. I.e. flow wise the dryer acts like a non-return valve.

The dryer and the piping upstream of the dryer might be depressurised when the pressure is decreased through air loss (e.g. through purge loss during the current regeneration).

This can be avoided by using a regeneration gas back-feed-line.

A regeneration gas back-feed-line is recommended for the following scenarios:

- When the piping upstream of the dryer shall not be depressurised.
- When the operation mode **“CYCLE STOP – FINISH CYCLE”** has been pre-selected and sufficient quantities of regeneration gas shall be available. (→Page Fehler! Textmarke nicht definiert.)
- When the compressor is operated via a pressure switch, that is installed upstream of the dryer and ... the volume between compressor and dryer is too small.
... the compressor is operated in a very narrow pressure band (i.e. the distance between start- and stop-pressure is too small).

Further options include:

- Special voltages: 115V – 50-60Hz , 24V-DC
- Wall-mounting supports
- Heated frost protection housing
- Differential pressure gauges with electric alarm contact (only for DPS6-8)
- Multistage pre- or after-filtration
- Oil adsorber as third vessel flanged to the dryer. (can be added to an existing dryer)

5. Operating elements

The following sections describe the dryer components used for dryer monitoring and dryer operation.

5.1 Power connector

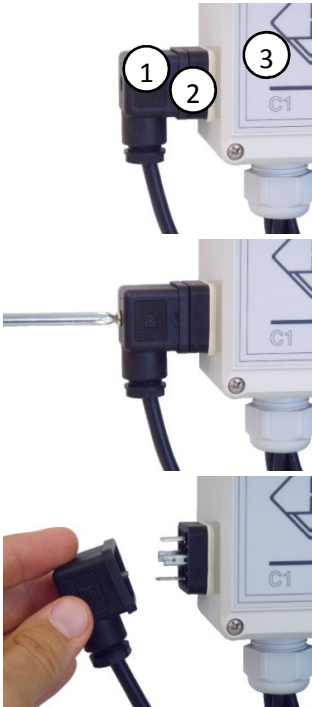

The power supply is connected via a female power connector (1) (part of the dryer scope)

Loosen the mounting screw of the power connector and pull the power connector off the male power connector (2).

Now the control (3) is disconnected for the power supply.



The main valves open when the power supply is interrupted

Please note that both main valves will open instantly when the power supply is interrupted. I.e. a pressureless vessel in regeneration mode will be pressurised via the main valve with a sudden pressure blow.

We recommend to wait until both vessels have reached equal pressure before you remove the female connector (e.g. when the cycle is close to the end of the “pressurisation phase” or during “stand-by”



Switch off the dryer from remote

The dryer consumes only little power. Therefore the dryer can be switched off by externally interrupting the power supply.

A standard line switch installed in the power supply line is sufficient to switch off the dryer.

The dryer control is fitted with a digital input port (“compressor contact”). The dryer program can be stopped and restarted via this “compressor contact” without interrupting the power supply. (→ Seite **Fehler! Textmarke nicht definiert.**)

5.2 Differential pressure gauges on the filters



The pre- and after-filter of some dryers are fitted with differential pressure gauges. The differential pressure gauge gives evidence of the condition and the degree of contamination of filter element.

For further information and instructions please refer to the manual of the filter and the differential pressure gauge.

5.3 Pressure gauge

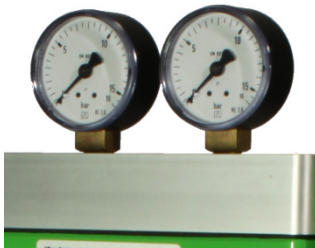

The vessel pressure of each vessel is shown on their respective pressure gauge PI01 / PI02.

The pressure gauges allow to monitor the proper function of the dryer. When the display shows “REG” the corresponding pressure gauge should indicate a pressureless vessel.

5.1 Control System

The dryer is operated by means of a display and three function keys on the control system.

5.1.1 Function Keys and Display

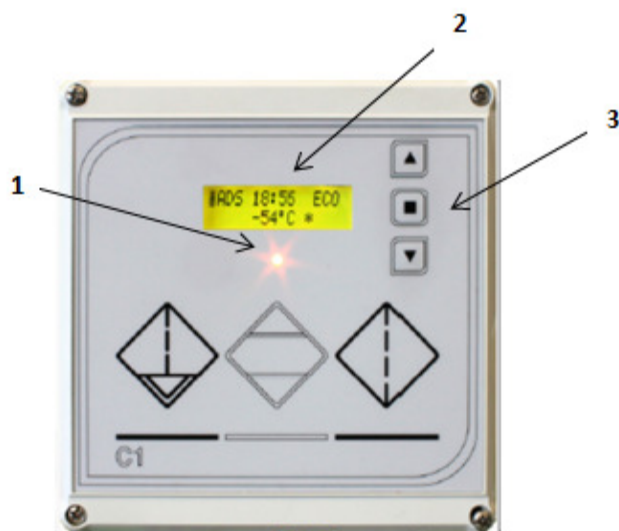

- 1 Status LED indicating operating states
- 2 Menu window
two-line LCD display showing program steps, remaining time, and pressure dew point
- 3 Control keys
for selection and change of values / parameters

The C1 control system is provided with supply voltage through the device plug. After having applied voltage, the display shows the software version number for about 5 seconds.

Then the C1 control system switches to the operating mode. The C1 control system starts from the program step in which it was shut down. All operating conditions and settings are saved persistently, i.e. after a power failure the control system continues the program automatically.

Operation and entry of parameters is effected by means of the three function keys (→ Item "Menu structure").

- ▲ Arrow key "UP" → for browsing the menu or incrementing figures (+).
- Enter key → for confirming changes.
- ▼ Arrow key "DOWN" → for browsing the menu or decrementing figures (-).

The menu window shows all relevant operating conditions, the corresponding remaining runtimes, and the pressure dew point (optional). After pressing a key, the background of the display is lit for 2 minutes.

Operating elements

The following table shows the most important operating messages of the display and their meaning.

Display	Meaning
ADS	Adsorption
REG	Regeneration
REP	Pressure build-up
CHG	Changeover
ECO	Economy mode
STB	Standby mode

Moreover, the status LED informs about energy saving mode and alarm conditions.

LED	Meaning
Green	Normal operation
Orange	Economy mode ECO is shown for a vessel
Red (flashing)	Alarm
Red (solid light)	Service required

5.1.2 Direct Indication

Press arrow key "UP" → ▲ or "DOWN" → ▼ to obtain additional information on operating mode, energy saving, and service timer status.



CYCLE MODE → Shows the operating modes **VAR** (variable cycle) or **FIX** (fixed cycle).

The displayed remaining runtime corresponds to the variable adsorption time extension which is limited to 2 hours. This time depends upon the dew point course of the previous cycles (only in mode **VAR**).



NEXT SERVICE → Indicates the time already elapsed (as a percentage value) until the service warning will be shown. This value depends on the actual utilisation of the dryer. For this value, the operating hours are counted during which the dryer regenerates. Depending on the degree of utilisation, the period until the display shows 100 % and the service warning is displayed may be of different lengths.

5.1.3 Menu Navigation

Access to the menu and thus to the parameters is protected by a password to prevent unauthorised intervention.

The password is:



Press the function keys as shown in a smooth and steady way!

Please consider that the password must be entered several times under certain circumstances!

The display shows:



The menu is divided into **SERVICE** and **PARAMETER**.

5.1.4 PARAMETER Level

Press the arrow key "UP" to access the **PARAMETER** level!

Various sensors for measuring and monitoring of pressure dew point, pressure, differential pressure, etc. as well as potential-free switch contacts of the compressor control system (load/no-load detection) and an external pressure dew point measuring device can be connected to the control system.

Operating mode, dew point analysis, function check, and alarms of the dryer can be set individually.

These settings affect performance and energy consumption of the dryer.

Operating elements

Operating modes



Setting of operating modes FIX and VAR

FIX → The dryer uses fixed cycle times assuming permanent full load operation irrespective of the input conditions. Adsorption and regeneration phase are of equal length in each cycle.

VAR → Changeover is effected when the measured pressure dew point exceeds the set limit value or after lapse of the **ECO** time. The adsorption time is being extended. Losses due to regeneration during operation of the dryer under partial load are thereby reduced.



Setting of operating modes DIREKT STOP and FINISH STOP (also refer to → Section 5.5.)

DIREKT STOP → When opening the compressor contact (load / no-load detection), the program of the control system is stopped immediately irrespective of the program step. Expansion valves V3 and V4 are no longer triggered. An unpressurised vessel is pressurised if necessary. When closing the contact (input IN1) again, the control system continues its program at this step.

FINISH CYCLE → Other than in operating mode **DIREKT STOP** the program of the control system is stopped only after lapse of the regeneration time. When closing the contact (input IN1) again, the control system continues its program at step "Changeover".

Dew point evaluation



Setting of limit value of pressure dew point (see Section 5.9)

Changeover is effected when the measured pressure dew point exceeds the set limit value.

Setting range: **-100 °C to PDP ALARM SET -1K**

[only effective with pressure dew point sensor being connected to terminal X9 and **CYCLE MODE VAR**]



Setting of pressure dew point alarm (see Section 5.9)

If the measured pressure dew point exceeds the set limit value, the pressure dew point is shown on the display and transmitted via terminal X6.

The alarm parameter must be higher than the limit value for the pressure dew point.

Setting range: **PDP SET +1K to +20 °C**

[only effective with pressure dew point sensor being connected to terminal X9; **CYCLE MODE VAR** or **FIX**]



Setting of measurement / evaluation of pressure dew point

In operating mode **VAR**, the dryer can be operated irrespective of the pressure dew point of the compressed air at the dryer outlet. For this purpose, either a pressure dew point sensor with output signal 4...20 mA (terminal X9) or a potential-free switch contact of an external pressure dew point measuring device (terminal X12) can be connected to the control system.

ANALOG → Connection of a pressure dew point transmitter to terminal X9 in the control system

DIGITAL → Connection of the potential-free switch contact of an external pressure dew point measuring device to terminal X12 in the control system

OFF → No pressure dew point sensor / switch contact connected to terminal X9 and terminal X12.



Setting of pressure dew point display

ON → The currently measured pressure dew point is shown in the display

[only with pressure dew point sensor being connected]

OFF → The currently measured pressure dew point is not shown in the display. You can continue to operate the dryer in **CYCLE MODE VAR**. The analogue output X10 on the printed circuit board remains active. If the measured pressure dew point exceeds the set limit value, the alarm is shown on the display and transmitted via alarm contact X6.

Setting of alarm output via display and / or terminal X6

ON → If the measured pressure dew point exceeds the set value for the "pressure dew point", the display shows **ALARM DEW-POINT** and at the same time the alarm is transmitted in a potential-free way via terminal X6 from the control system.

OFF → If the measured pressure dew point exceeds the set alarm dew point, **ALARM DEWPOINT** is shown on the display and no output is given via terminal X6 in the control system.



Setting of time interval for suppression of alarm output

The alarm can be inhibited for a certain period of time. Process-related variation of the dew point and possible short-term exceeding of the limit value connected therewith are not displayed. The alarm is transmitted only after lapse of the set time via display and terminal X6.

Setting range: **00:00:00h to 00:20:00 hours**

You can go to the next step by means of the Enter key.

Setting of the pressure dew point unit

The pressure dew point can be displayed in °C or °F.

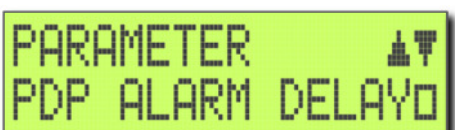

Evaluation of pressure / differential pressure



Setting of differential pressure alarm of pre-filter or failure condensate drain / pre-filter if wired correspondingly (ALARM FILTER1)

The differential pressure of the pre-filter element can be monitored by connecting a differential pressure gauge with potential-free switch contact to terminal X13 in the control system.

ON → The alarm will be transmitted via display and alarm relay.

OFF → No output of alarm on display and alarm relay.



Setting of differential pressure alarm filter 2 (ALARM FILTER2)

The differential pressure of the after-filter element can be monitored by connecting a differential pressure gauge with potential-free switch contact to terminal X14 in the control system.

ON → The alarm will be transmitted via display and alarm relay.

OFF → No output of alarm on display and alarm relay.



Setting of time interval for suppression of differential pressure alarms of pre-filter and after-filter

The alarm can be inhibited for a certain period of time. Process-related changes of differential pressure by varying volume flow and possible short-term exceeding of the limit value are thus not displayed. The alarm will be transmitted only after lapse of the set period via display and alarm relay.

Setting range: **00:00:00h to 00:20:00h**

You can go to the next step by means of the Enter key.



Setting of overload alarm

If the control system detects a differential pressure alarm at the same time on pre-filter and after-filter, this condition will be evaluated as exceeding of the operating parameter "volume flow".

ON → When simultaneously exceeding the differential pressure of pre-filter and after-filter, the alarm is transmitted via display and alarm relay.

OFF → No output of alarm on display and alarm relay.



Setting of time interval for suppression of overload alarm output

The alarm can be inhibited for a certain period of time. Process-related variation of differential pressure on pre-filter and after-filter and possible short-term exceeding of the limit value connected therewith are thus not displayed. The alarm is transmitted only after lapse of the set time via display and terminal X6.

Setting range: **00:00:00h to 00:20:00 hours**

You can go to the next step by means of the Enter key.



PARAMETER ▲▼
FUNCTION CHECK □

Setting of function check (as from version 2.10)

By means of separate pressure switches on vessel A1 and A2, the control system compares the operating pressure in the vessel to the current triggering of valves V1 to V4. Each program step is identified by corresponding vessel pressures and valve positions. (→ Chapter 5.10)

ON → Function check is activated.

OFF → Function check is deactivated



PARAMETER ▲▼
FCTN-CHECK-DLY □

Setting of time interval for suppression of alarm output "function check" (as from version 2.10)

Setting range: 00:00:00h to length of cycle step

You can go to the next step by means of the Enter key.

The alarm is transmitted only after lapse of the set time via display and terminal X6.



PARAMETER ▲▼
ALARM REMANENT □

Setting of alarm output

This parameter applies to all alarms!

ON → An alarm will be transmitted continuously via display, status LED, and terminal X6. The alarm output can only be stopped by pressing the Enter key.

OFF → The alarm message via terminal X6 of the control system is reset automatically as soon as the alarm cause is no longer present. The alarm message via display and status LED remains active.

Operating elements

5.1.5 SERVICE Level

The **SERVICE** level can be accessed by actuating the arrow key "UP".

By pressing the arrow key "UP", the relevant menu item is selected. By pressing the Enter key, the parameter level opens up. Here, the parameters can be changed by pressing the arrow keys "UP" and "DOWN". Afterwards, confirm the parameter by pressing the Enter key. The display returns to the menu item. The numeric codes on the service level can also be set by arrow keys "UP" and "DOWN". By pressing the Enter key, the cursor moves to the next digit until the entire code is entered.

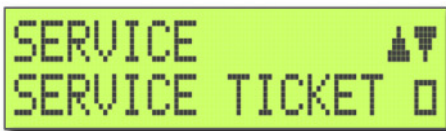

Entry of four-digit numeric codes to confirm the service warning (see Section 5.12.)

Each digit of the ticket number is entered using the arrow keys. You can go to the next step by means of the Enter key. The four-digit numeric code ("service ticket") is enclosed when purchasing original maintenance kits and can be used only once.



Display of previous load changes

For pressure vessels (here: drying agent vessels) which are subject to registration and for which the admissible number of pressure load changes (depressurise to atmosphere; pressurise up to maximum admissible operating pressure) is defined, an inspection of the vessel is to be effected by relevant organisations (authorised person or authorised supervisory organisation, e.g. German TÜV) after one half of the admissible number of pressure load changes. The number of pressure load changes already effected is shown here.



Display of current control of internal switching outputs Y1 to Y5 as well as A1 of control system

In the scope of maintenance and repair works, triggering of outputs Y1 to Y5 as well as alarm output A1 can be checked. Triggering cannot be influenced.

ON → The corresponding switching output is triggered

== → The corresponding switching output is not triggered

ATTENTION: Terminal X6 is used as alarm output and shows == in case of alarm / error.



Display of condition of digital switching inputs IN 1 to IN 4

In the scope of maintenance and repair works, the function and effectiveness of external switching elements (e.g. compressor contact for compressor synchronisation) can be checked, here.

ON → The connected switching contact is closed.

OFF → The connected switching contact is open.

5.1.6 Compressor Synchronisation Function

The control system allows to switch the dryer ON and OFF by means of terminal X11 via an external potential-free signal.

ATTENTION: The function "Compressor synchronisation" must only be used if the compressed air dryer is installed between compressor and compressed air storage!

A compressor contact or a remote ON / OFF switch can be connected to terminal X11.

In menu item **PARAMETER CYCLE STOP** you can select the response of the control system to the signal at terminal X11. The manufacturer delivers terminal X11 with a jumper. If this jumper and / or the connected contact is opened, the control program is stopped according to the respective setting.

Two options are available:

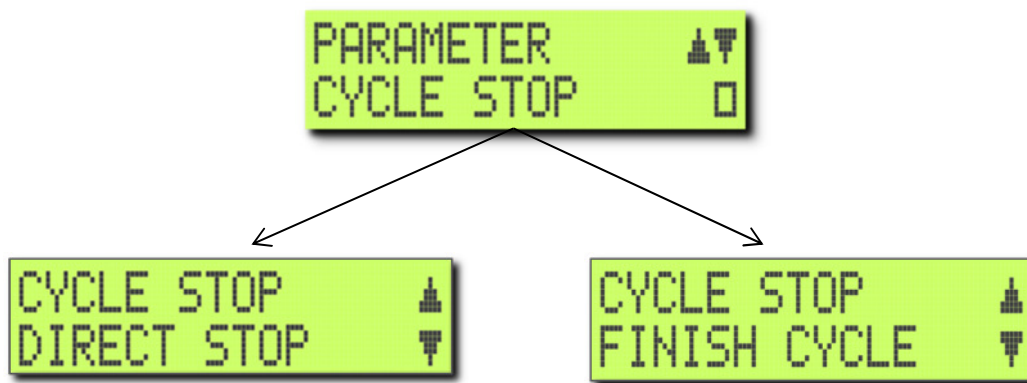

In mode **DIRECT-STOP** the control system stops immediately and outputs Y3 and Y4 are no longer controlled. Any unpressurised vessel is pressurised if necessary. All time values elapsed until then are "frozen" (stored).

In mode **FINISH-CYCLE** the control system is stopped only after the regeneration phase; valves Y3 and Y4 are no longer triggered.

Operating elements

Irrespective of how the cycle has been completed, the display shows **STB** for both vessels.



E.g. terminal X11 can be connected to the auxiliary contact of a compressor's contactor. Thereby, dryer and compressor are synchronised. The dryer regenerates only when compressed air is generated. This effect through the compressor contact does not have any influence on the triggering of inlet valves V1 and V2. Compressed air can flow through the dryer.

At this time, pending alarms in the control system are "frozen".

A dew point alarm is suppressed and displayed only after start of the dryer and lapse of the delay time.

The compressor contact can also be used as a remote switch and be connected to subordinate time or emergency control systems.

If the compressor contact is connected to terminal X11 again, the control system continues at that point where it was stopped.

5.1.7 Pressure Dew Point Measurement and Energy-saving Function

If the dryer is operating below its performance limit (i.e. not with maximum volume flow), it can generate a better (lower) pressure dew point value than prescribed by the set limit value. After regeneration, the dryer switches to the **ECO** mode and delays the next vessel changeover and / or regeneration phase until the measured pressure dew point exceeds the limit value or until the maximum admissible ECO time elapses. Information on the maximum **ECO** time can be seen on the direct display (→ See Section 5.4.)

This setting can be made in menu item:





PDP SENSOR
ANALOG

The pressure dew point transmitter with output signal 4...20 mA is connected directly to terminal X9 on the printed circuit board.



PDP SENSOR
DIGITAL

The potential-free switching output of an external pressure dew point measuring device is connected directly to terminal X12. No 4-20 mA signal is transmitted at terminal X10.

Contact connected to terminal X12: After lapse of the regeneration phase, the control system switches to the **ECO** mode.

Contact open at terminal X12: The control system is in **FIX** mode (time-dependant).



PDP SENSOR
OFF

The control system does not evaluate the dew point. Changeover of the vessels is effected on a time-dependant basis. No 4-20 mA signal is transmitted at terminal X10.

The following items are possible only with setting:



PDP SENSOR
ANALOG

The operating point of the dryer is prescribed by the changeover dew point. The latter can be set in menu **PDP SET** by means of the two arrow keys "UP" and "DOWN". The factory setting is -40 °C.

The pressure dew point alarm is set to 10° to 20° above the changeover dew point. This is how an excessive sensitivity to alarms is avoided. Sudden variations of the measured dew point value caused by pressure or load changes within the equipment are dependant upon the process and thus normal.

Release of a dew point alarm in case of so-called dew point peaks can be avoided by increasing the delay time.

5.1.8 Differential Pressure Monitoring of Filter

As an option, pre-filters and after-filters of an adsorption dryer can be fitted with differential pressure gauges with integrated switch contacts. Using the C1 control system, the signals of these contacts can be evaluated separately for pre-filter and after-filter and be displayed. Connection is provided via the switching inputs of terminal X13 and terminal X14.

It is possible to switch the alarms ON and OFF individually and to delay their transmission.

5.1.9 Overflow Monitor

If pre-filter and after-filter housings are provided with a differential pressure gauge with integrated switch contacts, an overflow evaluation can be effected by common query of both contacts. It is to be assumed that the dryer is subject to excessive load (volume flow too high) if the differential pressure switches at pre-filter and after-filter are activated at the same time.

In the factory configuration, the overflow indicator **ALARM OVERFLOW** is switched OFF (parameter **OFF**).

The delay time set in item **PARAMETER OVERF. ALARM DLY** must always be lower than that of the separate differential pressure monitoring of the filters under **PARAMETER FILTERALARM DLY**.

The control system's function is not affected thereby.

5.1.10 Service Ticket

The C1 control systems counts the switching cycles of the dryer's valves. The load changes of the vessels can thereby be displayed. Moreover, these values – in relation to the operating time of the dryer – allow to determine the actual utilisation of the dryer and thus also the consumption of drying agent as well as wear of pre-filter and after-filter. After having reached a limit value (approx. 1 year under normal conditions of use), a service warning is displayed.

In order to confirm the service warning, a four-digit numeric code – the so-called "service ticket" – is to be entered. When purchasing FST maintenance parts and filter elements, the customer obtains a new "service ticket" with the numeric code. Once entered the code cannot be used again. When the next service warning is displayed, the control system expects a new code.

Each number of the service ticket is to be entered individually by means of the arrow keys. Press the Enter key to select the next digit.

If the service ticket was entered correctly, the message **TIMER RESET DONE** is displayed. If the service ticket was not entered correctly, the message **TIMER RESET FAIL** is displayed.

If the service ticket was entered incorrectly, a new attempt can be made after about 2 minutes. Thereafter, the waiting time for the next attempt doubles each time the code is entered incorrectly until the correct code is entered.

5.2 Allocation Text on Display / Triggering of Valves

The following overview shows the pointer positions of the pressure gauges and valve positions in relation to the text on the display in the most important program steps.

Adsorption left / regeneration right

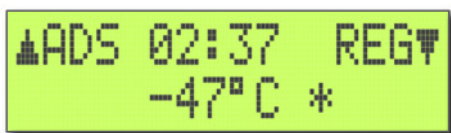

right vessel is unpressurised
left vessel is pressurised
valve V2 and valve V4 are triggered
valve V1 and valve V3 are not triggered

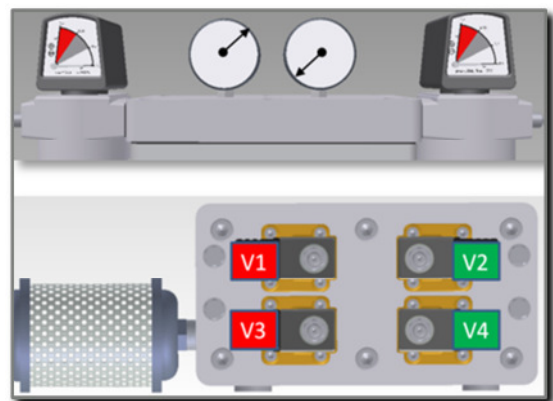

Bottom view of valve plate

Adsorption left / pressure build-up right



pressure build-up of right vessel
left vessel is pressurised
valve V2 is triggered
Valves V1, V3, and V4 are not triggered

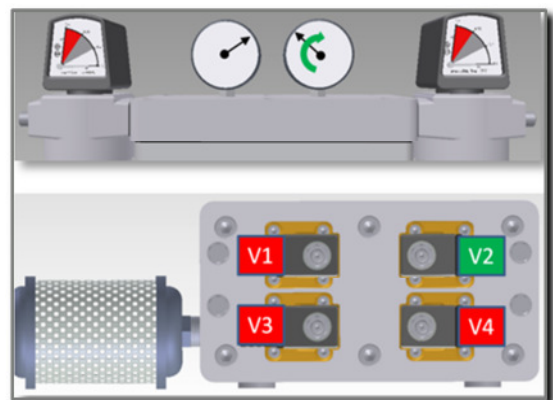

Bottom view of valve plate

Operating elements

Regeneration left / adsorption right

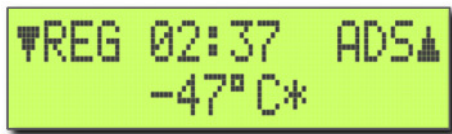

right vessel is pressurised
left vessel is unpressurised
valve V1 and valve V3 are triggered
valve V2 and valve V4 are not triggered

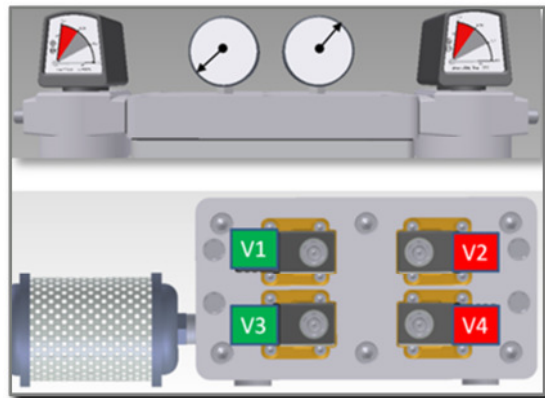

Bottom view of valve plate

Pressure build-up left / adsorption right



right vessel is pressurised
pressure build-up of left vessel
valve V1 and valve V3 are triggered
valve V2 and valve V4 are not triggered

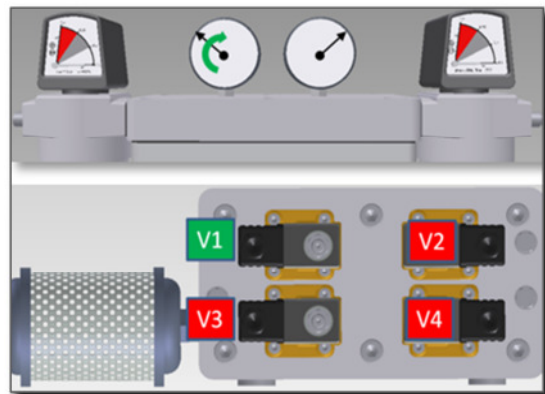

Bottom view of valve plate

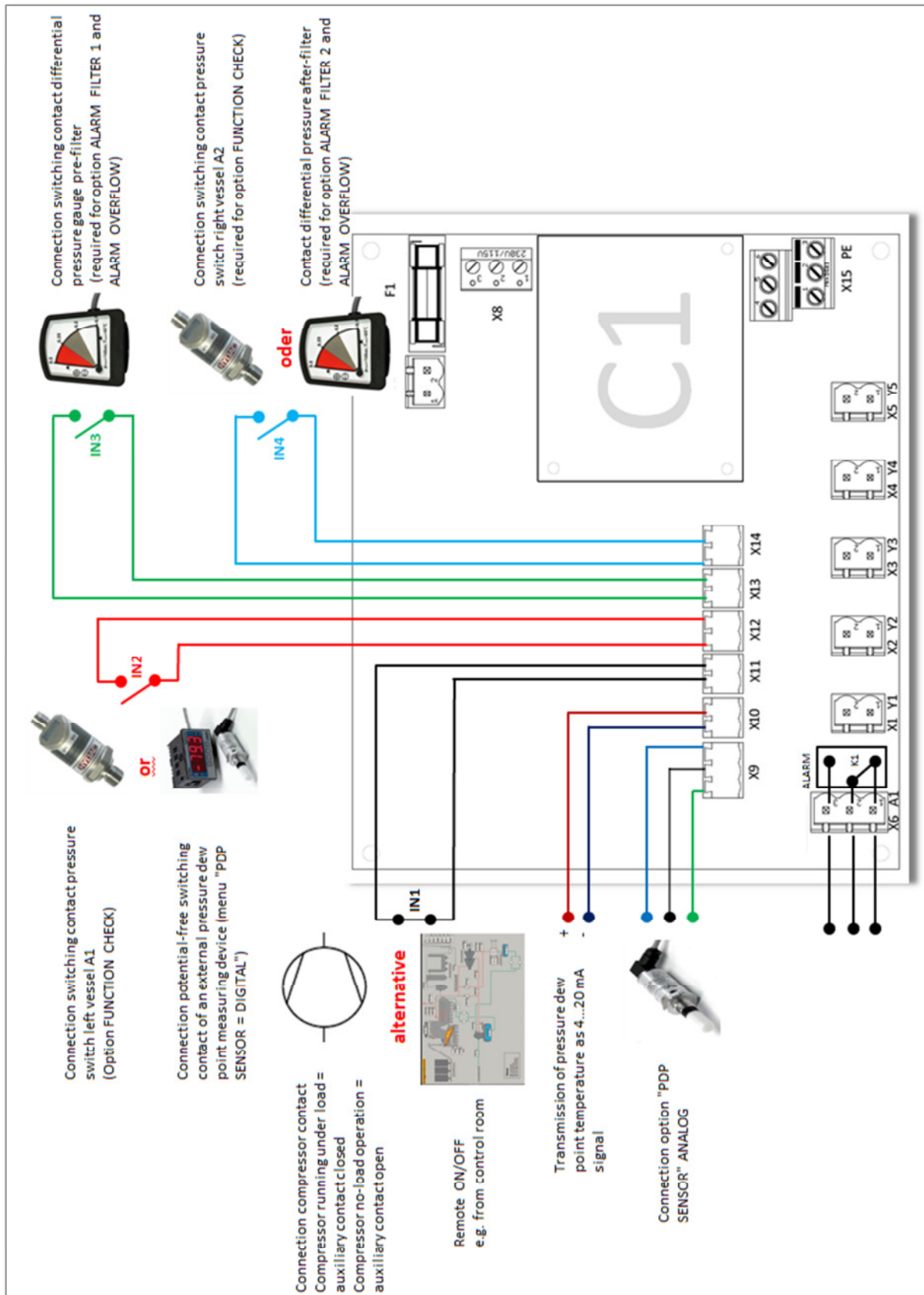



Operating elements

5.3 Failure Analysis

The following table provides a list of possible failures and alarms, their root causes and actions to be taken.

Only one alarm is shown on the display of the control system. If the control system detects several alarms, the last accumulated alarm is displayed.

Please observe the described safety notes when working on the dryer:

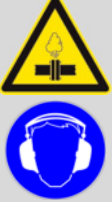
	<p>DANGER! – Overpressure (1;4) The dryer is pressurised. Suddenly escaping compressed air may result in serious injuries. Never perform any mechanical or electrical works on the dryer as long as it is pressurised.</p>
	<p>DANGER! – Electrical voltage (2;5) The dryer is operated with electrical voltage of up to 230 v. Touching of live components may cause serious injuries and death. Works on electrical components must only be effected by qualified and authorised personnel. Before starting any maintenance operations, make sure that the dryer was disconnected from the power supply and that no components are live using a voltage tester. In case of fire, do not extinguish using water.</p>
	<p>WARNING! – Suddenly escaping pressure (3) Pressure is released through a sound absorber about every 5 minutes. A loud and strong air blast may sweep away small parts and cause injuries. Do not place any small parts next to the sound absorber. The sound absorber must neither be manipulated nor removed. Wear ear protection when working close to the dryer.</p>

Failure	Cause	Action
Control system not in working order (no display) / status LED not lighted	Faulty power supply to control system C1	Check power supply
	Device plug mounted incorrectly	See Chapter "Installation Power Supply"
	Fine-wire fuse on printed circuit board defective	Replace fine-wire fuse, 500 mA slow-blow fuse; length 20 mm
Display "ALARM 24VDC"	Internal voltage monitoring of control system released	Remove voltage from control system, put into operation again after 30 seconds
Solenoid valve(s) is/are not triggered	Cable connection between printed circuit board and valve solenoid interrupted	Check cable connection and replace it if necessary
	Valve solenoid defective	Replace defective component
	No voltage applied to valve output on printed circuit board	Control system C1 defective; replace
No dew point value shown on display	Pressure dew point sensor is not registered in the control system	Register pressure dew point sensor in control system (proceeding see Section 5.4.3.1.)
Display "ALARM SENSOR" alternating with dew point display "--- °C"	Sensor cable connected incorrectly	Check connection of cable at plug to pressure dew point sensor and at terminal X9 on printed circuit board of the control system
	Sensor defective	Replace defective sensor
	Cable break	Replace sensor cable; pay attention to correct connection at sensor and control system (polarity)
Display "ALARM SENSOR" alternating with dew point display "+++ °C"	Sensor defective	Replace defective sensor
	Short circuit sensor cable	Replace defective sensor cable
	Sensor cable connected incorrectly	Check connection of cable at plug to pressure dew point sensor and at terminal X9 on printed circuit board of the control system
Pressure dew point indicated by control system deviates from separate measurement	Scaling of connected pressure dew point sensor deviates from scaling stored in the control system	Check sensor scaling (factory setting of control system: 4 mA = -100 °C; 20 mA = +20 °C)
Display "ALARM DEWPOINT"	Dryer overloaded due to deviating operating conditions	Check operating conditions of compressed air dryer (see Section 2.2.)
Display "ALARM OVERFLOW"	Both differential pressure switches on pre-filter and after-filter switched	Check operating conditions of compressed air dryer (see Section 2.2.)
		Check filter elements of pre-filter and after-filter. Excessive differential pressure by soiling

Operating elements

Failure	Cause	Action
No or insufficient pressure release of right or left vessel	Pressure-release valves V3 / V4 not open	Check supply line to valves V3 / V4
		Check valve solenoids of valves V3 / V4
	Upper check valves leaky	Remove, clean check valves
	High differential pressure at sound absorber by abraded drying agent	Replace sound absorber (proceeding see Section 10.1.6.)

6. Transportation, setting up and storage

6.1 Transportation

**DANGER ! – Damage**

Damages of the dryer may lead to unpredictable hazardous situations.

Operating a damaged dryer may result in serious injury or death.

Never start to operate a damaged dryer.

**DANGER ! – Risk of tilting**

The centre of gravity is in the upper part of the dryer.

Tilting of the dryer may result in serious injury or death.

During transport and during loading and unloading secure the dryer against tilting using the lifting lugs.

Although great care is taken damages caused by transportation cannot be ruled out. Therefore, always check the dryer for possible damages after transportation and packaging removal.

The haulage contractor and the manufacturer or the sales partner must immediately be informed about any damage.

- Make sure to provide adequate lifting equipment when transporting and loading or unloading the dryer.
- Persons responsible for transportation must be appropriately qualified.
- The dryer must only be lifted at the appropriate points using lifting equipment. (Transport pallet; base frame; support feet) (→ see Figure).
- Take the dryer weight and the maximum allowable load of the lifting and transport equipment used into account.
- Do not remove the packaging material until the dryer is moved to its final place of installation.
- The national regulations for accident prevention must be adhered to.

6.2 Setting up

Please refer to section "Description of application" (→ page 9). Here, you will find a list of requirements on the installation site.

Important data of the dryer can be found in section "Technical data" (→ page 11).

Additional requirements on the installation site:

- The ground for dryer installation must be level and capable to carry heavy loads. Ground irregularities must be levelled in order for tensional forces not to occur in the piping of the dryer.
- Because of noise emissions the installation site should not be in the vicinity of stationary workplaces.
- Keep a service distance to walls and other systems around the dryer of 0,1 m, minimum.
- During maintenance of the dryer components lifting equipment with adequate load capacity should be available and access of this equipment to the dryer must be ensured.
- The place of installation should not be in the vicinity of hallways in order to avoid risks to inexperienced persons.
- Set up the dryer such that the pressure gauge and the control are clearly visible and can be operated properly.

We recommend anchoring the dryer into the ground using the holes in the vessel supports.

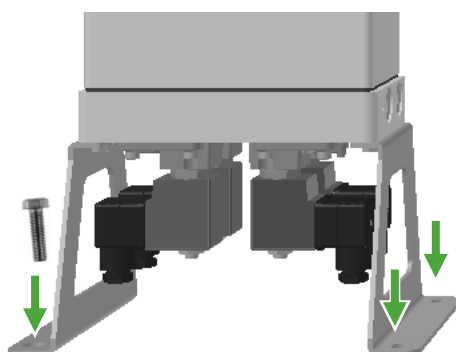

6.3 Storage

To maintain the dryer quality the dryer must be stored at a suitable location and properly prepared for storage.

The place of storage has to fulfil the following requirements:

- Indoors
- Protected against weather impact
- Frost-free
- Dry

If the dryer is to be stored immediately after delivery, it must only be protected against dust using an additional cover.

If the dryer has already been used for drying compressed air, please proceed as follows:

- 1) Disconnect the compressed air flow from the dryer by closing the valves up- and downstream of the dryer.
- 2) Change the setting of the control to „CYCLE MODE – FIX“. (→ Page **Fehler! Textmarke nicht definiert.**)
- 3) Operate the dryer for at least 4 more hours without compressed air flowing through the dryer. This ensures the dryer to be stored with dry vessels. The more regeneration cycles are performed, the dryer the desiccant.
- 4) Decommission the dryer. (→ Page 57)
- 5) Depressurise the dryer. (→ Page 58)
- 6) Disconnect the dryer from the electrical supply. (→ Page 25)
- 7) Disconnect the dryer from the compressed air system.
- 8) Close the inlets and outlets of the dryer using flange covers.
- 9) Place a desiccant bag in the control box.
- 10) Protect the dryer against dust using a cover.

To recommission the dryer after storage, please proceed as described for initial commissioning. (→ Page 54)



CAUTION ! – Moisture in electrical components

Long-term storage may lead to penetration of moisture into electrical components. This may result in short circuits or damages to these components.

Check the electrical dryer components for internal moisture.

The necessary actions (insulation resistance test) must only be performed by a qualified electrician.

7. Installation

7.1 Installing the connecting pipelines

**DANGER ! – Overpressure**

The dryer is under pressure.

Suddenly escaping compressed air may result in serious injury.

Do not carry out mechanical or electrical work on the dryer as long as the dryer is under pressure.

**DANGER ! – Overload**

The dryer must only be operated with compressed air within the maximum allowable operating conditions. The operating conditions are defined on the type plate (→ page 12).

Exceeding the maximum allowable operating conditions may result in serious injury or death.

It is the duty of the operator to ensure that the connected pressure source is safe-guarded such that the maximum allowable operating pressure (PS) and the maximum allowable temperature (TS) are not exceeded.

Please also refer to section “Intended use” (→ page 9).

**DANGER ! – Bursting components due to external forces**

The dryer components are not designed for externally applied forces and may burst due to additional load impact.

Bursting, pressure-bearing components may result in serious injury or death.

The support required for the connected pipelines has to be provided by the customer. Transmission of loads or stress into the connection flanges of the dryer is not permissible.

Proper installation is required for safe and error-free operation of the dryer.

Please observe the following steps when installing the compressed air pipeline (4) + (6):

- Make sure that the dryer and the compressed air system are free from pressure. If the compressed air system has to remain under pressure during installation, the shut-off valves have to be protected against unintentional opening. (2) + (8)
- The compressed air source (e.g. compressor) must be safe-guarded against exceeding of the maximum allowable operating pressure using safety equipment.
- The compressed air pipelines must be provided with shut-off valves used for disconnecting the dryer from the piping system (2) + (8). We recommend using shut-off valves with continuous opening behaviour (e.g. shut-off valves with stem or gear handwheel). This valve behaviour avoids sudden pressure equalisation between the piping sections.
- We recommend using a bypass line (11) around the dryer.
- The pipelines must be suitable for use with the maximum possible operating pressure.
- The transfer points (threaded connectors) have to be compatible to the dryer inlet and outlet with regard to nominal width, nominal pressure and type. (→ See general arrangement drawing in the appendix)
- Any vibrations or pulsation must not be transmitted to the dryer via the piping. This may damage the desiccant, the dryer control system or other components. If required, install compensators or pulsation absorbers in the pipelines to be connected.

- Wet pipelines upstream of the dryer (4) should be installed at a slope in order for condensate (water and oil) in the line to be discharged in flow direction. If installation of an upright pipeline is inevitable, a condensate drain must be provided at the lowest point of the pipeline. This avoids condensate from being accumulated in the pipeline and suddenly being swept away by the compressed air flow. These kinds of water shocks may damage the filter and dryer and must be avoided.
- Prior to closing the connected pipelines, please check that there are no objects or contaminations left in the pipelines.
- Remove the end caps from the dryer inlet and outlet.
- When checking the installation for leaks the maximum allowable operating pressure of the dryer must not be exceeded. (→ See specification on the type plate, page 12)
Never fill the dryer with water when performing a pressure test. Liquids will destroy the desiccant!

Installation example

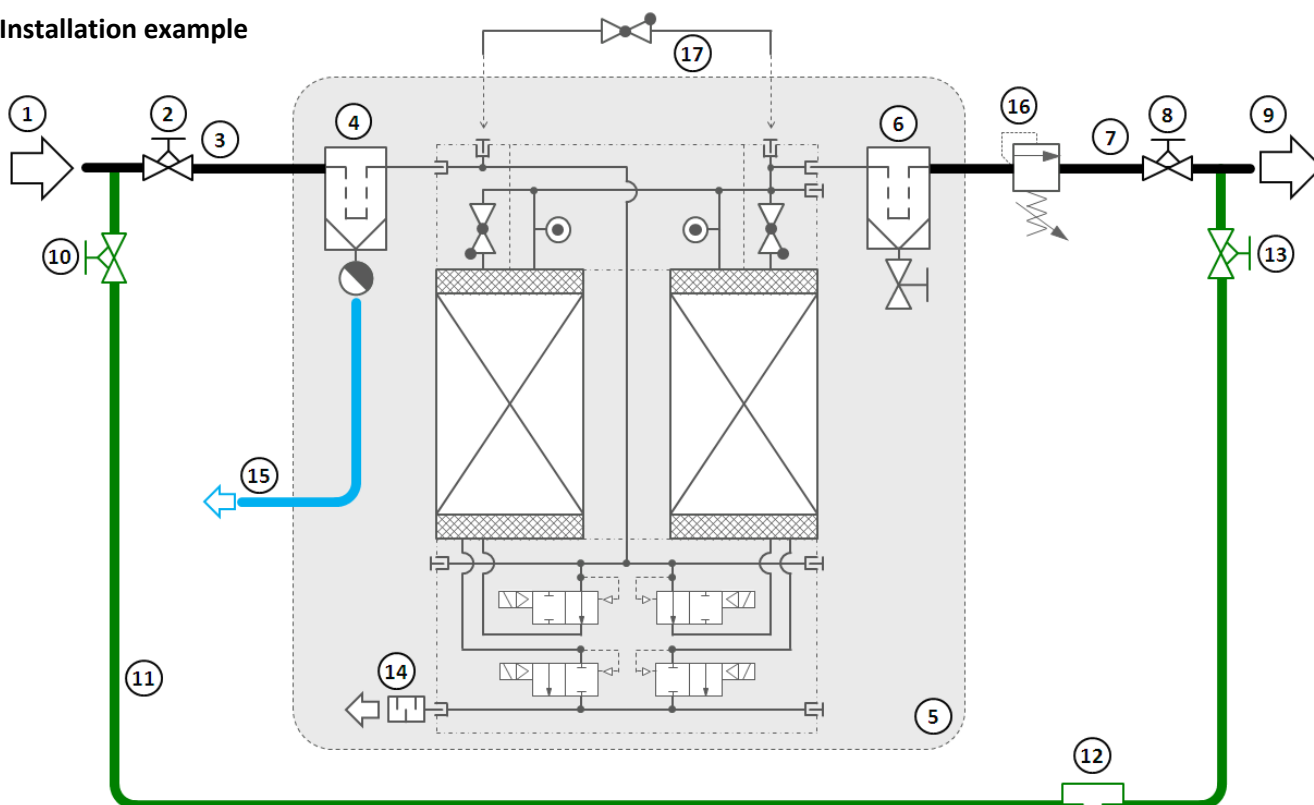

- | | |
|-------------------------------------|--|
| 1 Compressed air inlet | 9 Compressed air outlet |
| 2 Valve at compressed air inlet | 10 Bypass valve at inlet |
| 3 Compressed air pipeline at inlet | 11 Bypass line |
| 4 Pre-filter with condensate drain | 12 Bypass filter with condensate drain |
| 5 Dryer | 13 Bypass valve at outlet |
| 6 After-filter with manual drain | 14 Expansion silencer |
| 7 Compressed air pipeline at outlet | 15 Condensate line |
| 8 Valve at compressed air outlet | 16 Pressure maintaining valve |
| | 17 Regeneration back-feed-line |

Please note that the standard scope of supply only comprises the dryer (5) in the grey outline.

7.2 Installing the power supply



DANGER ! – Electric voltage

The dryer is operated at electric voltages up to 230 V.

Touching live parts may result in serious injury or death.



Work on electrical components must only be carried out by qualified and authorised personnel.

Use a voltage detector to make sure the dryer has been disconnected from the power supply and that there are no live parts before starting maintenance work.



In the event of fire, do not extinguish the fire using water.



CAUTION ! – Qualification and experience required

Persons working on and with the dryer have to be qualified personnel who, because of their qualification and experience, are familiar with handling compressed air systems and electrical systems. If you are not experienced in using these systems, please ask the relevant experts for help. We highly recommend that commissioning and maintenance be carried out by the manufacturer or one of the authorised service partners.



DANGER ! – Moisture and contamination in electrical components

Moisture and contamination in electrical components may lead to damages resulting in unpredictable dangers for the operating personnel. As a consequence, short circuits and faulty circuits may occur.

Always keep the control box and the terminal box dry and free from contamination and foreign bodies.

Make sure the control box and the terminal box are securely closed during operation.



Qualified electrician required

Electrical connection of the dryer must only be carried out by a qualified electrician who is familiar with reading electro-technical documentation.

For the data required for connecting and securing the voltage supply, please refer to the wiring diagram (→ see appendix: wiring diagram)

The power supply is connected via a female power connector on the dryer control box (part of the dryer scope):

- 1) Use a cable that is sufficiently sized for the voltage and power consumption of the dryer when connecting the dryer to the power supply. (→ see appendix: wiring diagram)
- 2) Make sure the power supply is switched OFF and secure it against unintentional reclosing.
- 3) Pull the female power connector off the male power connector on the control box. (→Page 25)

- 4) **Remove the mounting screw** (1) from the connector housing (2) first.
(The mounting screw serves as locking device for the connector insert (3). The connector insert cannot be removed from the housing of the power connector before the mounting screw has been removed.)
- 5) Carefully lift the connector insert (3) out of the connector housing using a small screw driver.
- 6) Lead the cable (8) through the various components of the cable gland:
(5) gland plug
(6) washer
(7) rubber seal
Now lead the cable through the gland opening in the connector housing (2).
- 7) Connect the leads of the cable according to the information in the wiring diagram.
- 8) Put the connector insert (3) back into the connector housing (2). Put the connector seal (4) back onto the female power connector and tighten the cable gland (5).

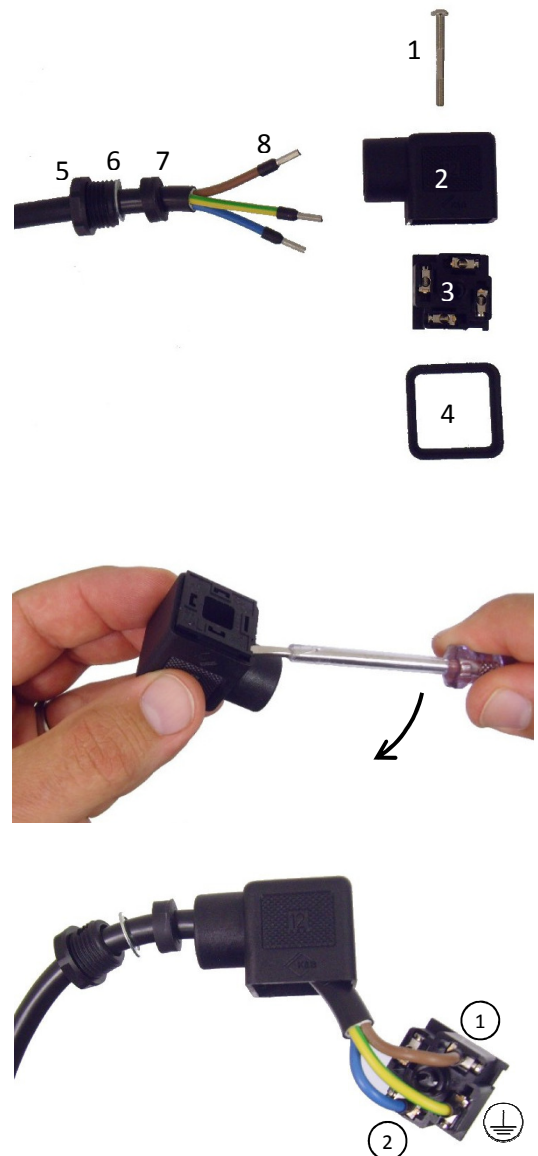

Communication interfaces

The dryer is provided with different signal inputs and outputs for dryer control and dryer monitoring. These communication interfaces are used to implement improved monitoring and economical operation of the dryer. For the interfaces, please refer to the wiring diagram (→ see appendix).

The connection of the signal cables is done via the cable glands on the bottom side of the control box:

- 1) Pull the female power connector off the male power connector on the control box in order to disconnect the dryer control from the power supply. (→Page 25)
- 2) Open the housing of the control box.
- 3) Individual ports for each IN and OUT signal are available on the circuit board. The allocation of these ports is shown in the wiring diagram.
- 4) Choose the cable type according to the details stated in the wiring diagram.
- 5) Loosen a cable gland with free cable ports and remove the blind plug from the cable feedthrough.

Installation

- 6) Connect the leads of the signal cable according to the information in the wiring diagram.

The standard scope of the dryer includes the most frequently used connector plugs and cable feedtroughs. Additional connector plugs and cable glands are required when all signal ports are used. Details of the connector plugs and cable glands can be found in the parts list of the wiring diagram.

8. Commissioning



CAUTION ! – Qualification and experience required

Persons working on and with the dryer have to be qualified personnel who, because of their qualification and experience, are familiar with handling compressed air systems and electrical systems. If you are not experienced in using these systems, please ask the relevant experts for help. We highly recommend that commissioning and maintenance be carried out by the manufacturer or one of the authorised service partners.

8.1 Requirements for initial commissioning

All the requirements for unhindered commissioning must be fulfilled, especially when commissioning is carried out by external qualified personal.

Make sure the following requirements for initial commissioning have been fulfilled:

- External qualified personnel have been informed about the commissioning date in good time (2 weeks in advance, minimum).
- External qualified personnel have been informed about the following in good time: special local conditions; site-specific safety guidelines; required safety instructions, if necessary; specially required qualifications, if necessary; special personal protective equipment.
- The place of installation can be freely accessed and entered without any risks.
- Neighbouring construction sites do not affect commissioning.
- The dryer is connected to the compressed air system using pipelines. (→ Page 48)
- The dryer is connected electrically and voltage supply is ensured. (→ Page 50)
- The compressor is ready to operate and personnel for starting and operating the compressor are present.
- Compressed air can be delivered to the downstream system. A volume flow rate of at least 40% of the nominal dryer performance can be led through the dryer.
- The dryer is classified pressure equipment (see declaration of conformity in the appendix). Prior to commissioning the dryer has to be approved by the local authorities according to the applicable national regulations. In the EU, the Pressure Equipment Directive 97/23/EC has to be observed.

Please check the following directly before commissioning:

- The operating limits must not be exceeded. (→ Page 9)
- The female power connector is pulled off and the control box is disconnected from the voltage supply. (→ Page 25)
- The shut-off valves provided by the customer and located upstream and downstream of the dryer are closed.
- The connections may have become loose due to dryer transportation. Make sure the piping connections, screwed joints and pneumatic lines are tightly secured. Tighten loose connections using the appropriate tools.

Commissioning

- Make sure the cable clamps in the control box are tightly secured. Tighten all the screw connections using the appropriate tools.
- Check all the components for visible damages. If there are defective components, commissioning of the dryer is not permitted!



DANGER ! – Moisture and contamination in electrical components

Moisture and contamination in electrical components may lead to damages resulting in unpredictable dangers for the operating personnel. As a consequence, short circuits and faulty circuits may occur.

Always keep the control box and the terminal box dry and free from contamination and foreign bodies.

Make sure the control box and the terminal box are securely closed during operation.

8.2 Commissioning the dryer



DANGER ! – Overpressure

The dryer is under pressure.

Suddenly escaping compressed air may result in serious injury.

Do not carry out mechanical or electrical work on the dryer as long as the dryer is under pressure.



DANGER ! – Electric voltage

The dryer is operated at electric voltages up to 690 V.

Touching live parts may result in serious injury or death.



Work on electrical components must only be carried out by qualified and authorised personnel. Use a voltage detector to make sure the dryer has been disconnected from the power supply and that there are no live parts before starting maintenance work.



In the event of fire, do not extinguish the fire using water.



WARNING ! – Suddenly escaping compressed air (3)

The dryer is depressurised approximately every 6 hours using a silencer. A loud and strong air-stream may carry small particles and cause injury.



Do not place any equipment in the vicinity of the silencer. The silencer must not be manipulated or removed. Always wear hearing protectors when working in the vicinity of the dryer.

If all conditions required for commissioning are fulfilled, the commissioning procedure can be started. Perform the following steps in the listed order.

8.2.1 Pressurisation of the dryer



CAUTION ! – Pressure blows and overload

Rapid opening of the valves may cause pressure blows and increased flow rates in the dryer. Pressure blows and increased flow rates may lead to damages of the dryer.



Open the valves **very slowly** and make sure that the flow noise does not become too loud. Pay special attention when opening valves that can be opened rapidly by means of a pivoting movement.

The dryer valves are controlled by compressed air which is supplied from inside the dryer. For this reason the first requirement for commissioning is reaching a minimum pressure of 4 bar in the dryer. Pressurise the dryer as follows:

- 1) Make sure the compressed air system upstream of the dryer inlet is under pressure. If necessary, the compressor must be started.
- 2) Open the valve upstream of the dryer inlet **very slowly** until hearing the first clear flow noise. Stop the procedure when the flow noise becomes loud.
- 3) Observe the vessel pressure gauges. Pressurisation can be monitored on one of the two pressure gauges. Make sure the pressure is only rising slowly. Pressurisation speed may not exceed 2 bar/min.
- 4) Check the system for leaks during pressurisation. In the event of leaks, pressurisation must be stopped and the leaks must be repaired. To repair the leaks the dryer has to be depressurised again. (→ Page 58)
- 5) If flow noise and a pressure increase is no longer present when further opening the valve, it can be opened completely.

8.2.2 Opening the outlet valve

Special attention must be paid if the compressed air system downstream of the dryer is free from pressure.

- 1) Open the valve downstream of the dryer outlet **very slowly** until hearing the first clear flow noise.
- 2) Observe the vessel pressure gauges. Make sure there is no sudden pressure drop in the vessel. The vessel pressure may not drop for more than 1 bar.
- 3) If flow noise is no longer present when further opening the valve, it can be opened completely.
- 4) Air can now freely flow through the dryer. If a volume flow is to be transferred via the dryer, commissioning should be performed quickly or the valve downstream of the dryer outlet should be closed again, in order for the dryer not to be overladen with moisture during standstill.



Automatic start-up device

In the event the dryer is frequently started against a pressureless compressed air system, we recommend using an automatic start-up device. (→ Page 24)

The automatic start-up device prevents pressure blows and increased flow speeds from occurring even when the compressor is started automatically.

8.2.3 Starting the dryer

- 1) Make sure the dryer is under pressure and that all the valves upstream and downstream of the dryer are opened in order for the compressed air to be able to flow through the dryer.
- 2) Put the female power connector onto the male power connector on the control box. (→Page 25)
Now the display is illuminated and the software version of the control appears on the display for a few seconds. The dryer programs starts up. The start of the program is accompanied by a notable clicking of the valves (V1-4)
- 3) Acknowledge any alarm messages, if required.
- 4) If any alarm messages are present that cannot be acknowledged, please proceed as described in section "Error messages and measures". (→ Page **Fehler! Textmarke nicht definiert.**)
- 5) If there are no additional alarm messages, the dryer has been commissioned properly.

Monitor dryer operation. The dryer now performs the phases described in section "Function description". (→ Page 20)

9. Shutting down and restarting the dryer

9.1 Shutting down the dryer in case of emergency

- 1) Disconnect the power supply to the dryer. (e.g. by pulling the power connector off the control box. (→ Page 25)
- 2) Close the valves upstream and downstream of the dryer.
- 3) The dryer has now been shut down.

9.2 Stopping the dryer

The dryer can be stopped by ...

- 1) Disconnecting the power supply.
- 2) Pulling the power connector off the control box.
- 3) Opening the “compressor contact”. . (→Page **Fehler! Textmarke nicht definiert.**)

Compressed air must no longer flow through the dryer. Otherwise, it is overladen with moisture.

Please note that the dew point becomes worse after a certain standstill period. Worsening of the dew point is not a dryer error but is caused by external moisture slowly penetrating the static volume in the piping. As soon as the compressed air flows again, the dew point will also become better again

9.3 Shutting down the dryer

- 1) Stop the dryer as described in the above section.
- 2) Pull the power connector off the control box.
- 3) Close the valves upstream and downstream of the dryer.
- 4) The dryer has now been shut down.
- 5) Prior to working on the dryer it has to be depressurised.

Shutting down and restarting the dryer

9.4 Depressurising the dryer



WARNING ! – Exhausting pressure

Compressed air exhausting to the outside is very loud and may carry small particles. This may cause hearing damage as well as injuries of the eyes and of the skin.



Close the openings used for releasing the pressure by means of a silencer suitable for the pressure.

Open the valves for releasing the pressure only **very slowly**.



Always wear eye and hearing protectors when working in the vicinity of the dryer.

- 1) Close the valves upstream and downstream of the dryer.
- 2) Open the valve on the after-filter or the condensate drain at the pre-filter, respectively.
- 3) Monitor the pressure on the pressure gauges of the dryer.
- 4) Wait until the pressure has dropped to 0 bar on both pressure gauges.

9.5 Restarting the dryer

Please proceed as described in chapter "Commissioning". (→ Page 54)

If the relevant requirements have already been fulfilled, the corresponding steps of the chapter can be skipped.

10. Maintenance and repair



DANGER ! – Overpressure

The dryer is under pressure.

Suddenly escaping compressed air may result in serious injury.

Do not carry out mechanical or electrical work on the dryer as long as the dryer is under pressure.



DANGER ! – Electric voltage

The dryer is operated at electric voltages up to 230 V.

Touching live parts may result in serious injury or death.



Work on electrical components must only be carried out by qualified and authorised personnel.

Use a voltage detector to make sure the dryer has been disconnected from the power supply and that there are no live parts before starting maintenance work.



In the event of fire, do not extinguish the fire using water.



CAUTION ! – Qualification and experience required

Persons working on and with the dryer have to be qualified personnel who, because of their qualification and experience, are familiar with handling compressed air systems and electrical systems. If you are not experienced in using these systems, please ask the relevant experts for help. We highly recommend that commissioning and maintenance be carried out by the manufacturer or one of the authorised service partners.

Please observe the following requirements for maintenance:

- Observe the notes in section "Intended use". (→ Page 9)
- Observe the "Safety notes" and the "General safety notes" in particular. (→ Pages 12, 14)
- Provide the required spare parts. Only use genuine spare parts of the manufacturer. The manufacture provides prepared spare part packets. (→ Page 5)
- Maintenance must only be carried out if the dryer is depressurised and disconnected from the power supply.

Please observe the following when completing maintenance work:

- Make sure that all the flange connections and screwed joints are tight and sealed.
- Carry out a leak test.
- Make sure not to forget any tools, detergents or other objects in and around the dryer.
- Commission the dryer as described on → page 54.



Maintenance contract

It is possible to conclude a maintenance contract with the manufacturer or one of their service partners. A maintenance contract guarantees that the dryer has been maintained regularly by qualified personnel and that only genuine spare parts are being used.

For contact data, please refer to → page 5.

For communication purposes, please specify the type and the manufacturing number. This information can be found on the type plate on the control box of the dryer. (→ Page 12)

10.1 Regular maintenance intervals

The following table gives an overview of routine maintenance tasks. The required activities are described on the following pages.

Component	Maintenance activity	Every day	Every month	Every year	Every 2 years	Every 4 years	See page
Dryer and dryer control	Visual check and function monitoring	■					60
Dryer	Clean		■				61
Control box	Check if cable and terminals are securely fixed			■			61
Dew point sensor (MT01)	Calibration required			■			61
Pre- and after-filter	Replace filter element			■			62
Expansion silencer (X1)	Replace			■		■ *	62
valves (V1-V4)	Replace sealing set				■		63
valves (RV1-2)	Replace sealing set					■	63
Demister (SD1)	Replace					■ *	
desiccant	Check/replace					■ *	63

* = These activities should be carried out at the same time.

10.1.1 Visual check and function monitoring

- 1) Check the dryer for external damages.
- 2) Check the operating parameters of the incoming compressed air (pressure and temperature in particular). (→ Page 11)
- 3) Check the individual components for unusual noise development and leaks.
- 4) Check the error messages on the touch panel and, if required, proceed as described in section "Alarm messages". (→ Page 42)
- 5) Check if the condensate drains on the compressor and on the upstream filters are working properly.
- 6) Check the dew point.

10.1.2 Cleaning the dryer and dryer control

Make sure the surroundings are clean and tidy.

- 1) Clean the dryer surface using a slightly moist cloth. Do not use detergents containing acids or solvents.
- 2) Make sure the operating elements and the type plates can always be clearly read.
- 3) Keep water and metallic dust away from the electrical components.

10.1.3 Checking if cable and terminals are securely fixed

The cable connections may be loosened due to transportation or vibrations. To prevent malfunctions from occurring, all the cable connections must be checked to ensure that they are securely fixed. In the event of heavy vibrations, inspection must be carried out more frequently. The necessary actions must only be performed by a qualified electrician.

- 1) Decommission the dryer. (→ Page 57)
- 2) Depressurise the dryer. (→ Page 58)
- 3) Disconnect the electrical power supply from the dryer and protect it against unintentional reconnection.
- 4) Make sure the cables and terminals are securely fixed by tightening them, if required.
Only use tools approved for electrical work.
- 5) Replace any damaged or corroded components.
- 6) After the control box has been reclosed, the dryer can be recommissioned again.

10.1.4 Calibrating the dew point sensor

The dew point sensor (MT01) is subject to ageing which leads to inaccurate measurements over time. Oil vapour and other contamination may render the sensor unusable over time. To prevent operating errors from occurring the dew point sensor must be calibrated regularly.



Delicate dew point sensor

The dew point sensor contains a very delicate electronic system. Vibrations and shocks may lead to sensor damage. Handle the sensor with particular care.

- 1) Decommission the dryer. (→ Page 57)
- 2) Depressurise the dryer. (→ Page 58)
- 3) Loosen the screw at the sensor cable socket and remove the cable socket. The cable socket is kept at the dryer and will be reused.
- 4) Unscrew the sensor from the measuring socket using an appropriate wrench. Only hold the sensor at the hexagon of the sensor housing!
- 5) Insert a calibrated sensor of the same type in the measuring socket.
- 6) Plug the cable socket onto the calibrated sensor and tighten the cable socket.
- 7) Pressurise the dryer and commission the dryer again. (→ Page 57)



Replacement program

The manufacturer provides a replacement program for old dew point sensors.

- 1) Order a new dew point sensor.
- 2) Exchange the sensors upon receipt of the new sensor.
- 3) Send the old sensor back to the manufacturer. For this purpose, use the protective packaging of the new sensor. Only sensors that are undamaged can be recalibrated!
- 4) After receipt of the old, undamaged sensor the price difference of the new sensor and calibration will be credited. The old sensor remains at the manufacturer.

10.1.5 Replacing filter elements

The filter elements in the filters prevent particles and aerosols in the compressed air flow from entering the system. The filter elements in the filters will be clogged over time and thus the compressed air flow is throttled. To prevent operating errors from occurring, the filter elements have to be replaced regularly. Check the differential pressure gauge at the filter (if available). When exceeding approximately 350 mbar, the elements should be replaced. Replacement is due after one year at the latest.

- 1) Depressurise the filter. (→Page 58)
- 2) For filter replacement please proceed as described in the operating manual of the filter.

10.1.6 Replacing the expansion silencer

The expansion silencer (X1) is contaminated by dust and condensate over time and thus the expansion air flow is throttled. To prevent operating errors from occurring, the expansion silencer has to be replaced regularly.

- 1) Decommission the dryer. (→ Page 57)
- 2) Depressurise the dryer. (→ Page 58)
- 3) Lock the connecting part between valve V5 and expansion silencer (X1) using an appropriate tool in order for valve (V5) not to turn.
- 4) Unscrew the old expansion silencer (X1) from the connecting part using your hands or an appropriate tool.
- 5) Screw the new expansion silencer (X1) in the connecting part and tighten it using your hands or an appropriate tool and some sealing tape.
- 6) Pressurise the dryer and commission the dryer again. (→ Page 57)

10.1.7 Replacing the sealing set of the valves (V1-4) and the check valves (RV1-2)

The valves and check valves are subject to wear. The seals must be replaced in regular intervals. Spare part kits containing all parts required for proper maintenance can be purchased from the manufacturer or one of his service partners

10.1.8 Checking and replacing the desiccant



CAUTION ! – Desiccant dust

Using the desiccant may lead to mineral dust formation.
Desiccant dust may cause eye and respiratory tract irritations.
Wear eye protection and a dust mask when handling the desiccant.



WARNING ! – Risk of slipping

After desiccant replacement some amounts of desiccant may still remain on the floor.
The desiccant is very slippery and may result in serious fall injury.
Immediately remove residual desiccant properly from the floor.

The desiccant is subject to ageing and its drying performance is reduced over time. The service life of the desiccant depends on numerous operating parameters and cannot be exactly predicted. The service life is approximately 3 to 5 years. Under very favourable conditions (e.g. oil-free compressed air) the service life may be considerably longer. The quality of the desiccant can be assessed quite well when monitoring the operating phases. If the adsorption phase is reduced significantly during operation in the „CYCLE MODE - VAR“ mode, the desiccant should be replaced. Desiccant replacement is generally useful as a preventive maintenance measure in conjunction with other repair work. (See advisory note below)



WARNING ! – Risk of falls

The dryer must never be used as a climbing aid. The dryer components will not provide adequate support and parts of the dryer may break off. Disregard may lead to dryer damages and falls with serious injuries.
When working at height only use approved climb assist systems.

Desiccant replacement is part of a large inspection run. At the same time, other maintenance activities should be carried out. (See maintenance table → page 60)

- 1) Decommission the dryer. (→ Page 57)
- 2) Depressurise the dryer. (→ Page 58)
- 3) Remove the upper check valve block. (RV1, RV2)
- 4) Replace the demister-pads (SD1)
- 5) Provide an adequately sized container for the used desiccant.
- 6) Remove the used desiccant from the vessel using a suction device (e.g. vacuum cleaner).

Maintenance and repair

- 7) Remove the used desiccant from the construction site.
- 8) Provide the new desiccant. In case two different desiccants shall be used, make sure that the two different desiccant types create two separate layers in the vessel.
Distribute the different desiccant types equally to the two vessels.
In the event you are unsure which desiccant to fill in first, please contact the manufacturer.
- 9) Fill in the liquid waterproof desiccant (silica gel WS) first. It is the lower layer in the vessel.
- 10) Fill in the desiccant (molecular sieve) last. It is the upper layer in the vessel.
- 11) Fill up the vessel almost to its full extent. Make sure that the demister-pads (SD1) can still be inserted into the vessel.
- 12) Place the upper check valve block back onto the twin vessel (A1,A2) using a new flat gasket.
- 13) Close the twin vessel with the upper check valve block. First tighten the screws only lightly. Then tighten completely in a crosswise manner.
- 14) Clean the bottom thoroughly from desiccant residues.
- 15) Slowly pressurise the dryer again. (→ Page 55) Carry out a leak test using a leak detection spray. In the event of leaks the dryer will have to be depressurised prior to repairing the leaks.

Please note that, directly after desiccant replacement, the dew point may become worse. The new desiccant will reach the full drying performance only after a longer operation period.

For the time directly after desiccant replacement it may be useful to select a dew point limit value as described in the "Properly selecting the dew point limit value" advisory note. (→ Page 10)



Increased dust contents after desiccant replacement

Filling the new desiccant in the dryer results in increased dust contents in the vessels. In the first weeks after recommissioning the dust is forwarded to the downstream filter and the filter elements will deteriorate faster than during later operation. We therefore recommend to recommission the dryer using the old filter elements and to use the new filter elements and the new expansion silencer only after some weeks.



Desiccant

The desiccant used is not subject to labelling requirements according to the Hazardous Substances Ordinance. Nevertheless, the common safety measures with regard to using chemicals apply.

The manufacturer will provide safety data sheets on request.

The desiccant may accumulate contaminants from the compressed air. Depending on the type of contamination there may be a risk of injury or damage when using the desiccant. As the type of contamination is not known to the manufacturer, the resulting risks cannot be evaluated in this operating manual.



Disposal

Dispose of the desiccant according to the local regulations.

Waste codes according to the Waste Catalogue Ordinance:

- Non-contaminated desiccant: 06 08 99
- Contaminated desiccant: The waste code will have to be determined by the waste producer taking the type of contamination into consideration. The desiccant must be disposed of in an appropriate disposal plant.

EC – Declaration of Conformity

acc. to the low voltage directive 2006/95/EC

Herewith we declare that the below mentioned products in their conception and design in which we placed them on the market have undergone the procedures of conformity assessment acc. to the above mentioned directive and are in conformity with this directive.

Manufacturer/authorised representative:	FST GmbH Weiherdamm 17 57250 Netphen, Germany
Description of the assembly:	adsorption dryer type DPS1 to DPS2 and DPS1A to DPS2A DPS1BI to DPS2BI and DPS1BM to DPS2BM
Description of the pressure equipment constituting the assembly:	The dryer is described in the operating manual in detail.
Harmonised standards applied:	DIN EN ISO 12100; DIN EN ISO 60204-1; DIN EN 60730-1; DIN EN 55011; DIN EN 61000-6-2; DIN EN 61000-3-2; DIN EN 61000-3-3; DIN EN 12266
Other Community Directives applied:	2004/108/EG; 97/23/EG

In case changes are made to the product without prior consultation and written approval by the manufacturer this declaration will become void.

Unterschrift:

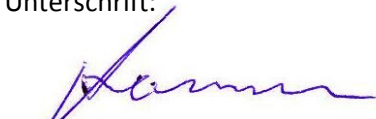

22.01.2015, Norbert Hannen, Geschäftsführer



EC – Declaration of Conformity

acc. to the pressure equipment directive 97/23/EG

Herewith we declare that the below mentioned products in their conception and design in which we placed them on the market have undergone the procedures of conformity assessment acc. to annex III of the above mentioned directive and are in conformity with this directive.

Manufacturer/authorised representative:	FST GmbH Weiherdamm 17 57250 Netphen, Germany
Description of the assembly:	adsorption dryer type DPS3 to DPS8 and DPS3A to DPS8A DPS3BI to DPS8BI and DPS3BM to DPS8BM
Description of the pressure equipment constituting the assembly:	The dryer is described in the operating manual in detail.
Conformity assessment procedure followed:	Module A
Harmonised standards applied:	DIN EN ISO 12100; DIN EN ISO 60204-1; DIN EN 60730-1; DIN EN 55011; DIN EN 61000-6-2; DIN EN 61000-3-2; DIN EN 61000-3-3; DIN EN 12266
Other Community Directives applied:	2004/108/EG; 2006/95/EG

In case changes are made to the product without prior consultation and written approval by the manufacturer this declaration will become void.

Unterschrift:

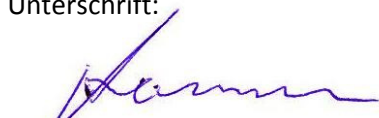

22.01.2015, Norbert Hannen, Geschäftsführer

11.3 General arrangement drawing

Separate document

11.4 Process flow diagram

11.5 Wiring diagram